

2013

# Crime Scene Investigation

A Guide For Law Enforcement



**NIST**



# Crime Scene Investigation

## A Guide for Law Enforcement

*September 2013*

Original guide developed and approved by the Technical Working Group on Crime Scene Investigation, January 2000.

Updated guide developed and approved by the Review Committee, September 2012.

Project Director: Kevin Lothridge

Project Manager: Frank Fitzpatrick

National Forensic Science Technology Center

8285 Bryan Dairy Road, Suite 125

Largo, FL 33777

Revision of this guide was conducted by the National Forensic Science Technology Center (NFSTC), supported under cooperative agreements 2009-D1-BX-K028 and 2010-DD-BX-K009 by the Bureau of Justice Assistance, and 2007-MU-BX-K008 by the National Institute of Justice, Office of Justice Programs, U.S. Department of Justice.

This document is not intended to create, does not create, and may not be relied upon to create any rights, substantive or procedural, enforceable at law by any party in any matter, civil or criminal.

Opinions or points of view expressed in this document represent a consensus of the authors and do not necessarily reflect the official position of the U.S. Department of Justice.

# Contents

<b>A. Arriving at the Scene: Initial Response/ Prioritization of Efforts.....</b>	<b>1</b>
1. Initial Response/ Receipt of Information .....	1
2. Safety Procedures .....	2
3. Emergency Care.....	2
4. Secure and Control Persons at the Scene.....	3
5. Boundaries: Identify, Establish, Protect and Secure.....	4
6. Turn Over Control of the Scene and Brief Investigator(s) in Charge .....	6
7. Document Actions and Observations .....	6
8. Establish a Command Post (Incident Command System) and Make Notifications.....	7
9. Manage Witnesses.....	8
<b>B. Preliminary Documentation and Evaluation of the Scene.....</b>	<b>10</b>
1. Conduct Scene Assessment.....	10
2. Conduct Scene “Walk-Through” and Initial Documentation .....	11
3. Note-Taking and Logs .....	13
<b>C. Processing the Scene.....</b>	<b>15</b>
1. Determine Team Composition.....	15
2. Ensure Contamination Control.....	15
3. Documentation .....	16
<i>Sketching</i> .....	17
<i>Photography</i> .....	27
<i>Videography</i> .....	35
4. Prioritize Collection of Evidence .....	38
5. Crime Scene Search Methods .....	39
6. Collect, Preserve, Inventory, Package, Transport, and Submit Evidence .....	42
7. Detailed Crime Scene Evidence Collection .....	42
<i>Ignitable Liquids</i> .....	43
<i>Bodily Fluids</i> .....	43
<i>Male Suspect Evidence Collection, Including Sexual Assault</i> .....	54
<i>Bombs and Explosives</i> .....	56

<i>Documents</i> .....	57
<i>Firearms</i> .....	61
<i>Ammunition</i> .....	67
<i>Tool Mark Evidence</i> .....	71
<i>Trace Evidence</i> .....	73
<i>Footwear and Tire Impressions</i> .....	98
<i>Footwear Impression Evidence</i> .....	101
<i>Motor Vehicles</i> .....	111
<i>Electronic and Digital Evidence</i> .....	113
<i>Fingerprints</i> .....	134
<i>Comparison/Elimination Prints</i> .....	139
<i>Tool Mark Evidence</i> .....	142
<b>D. Completing and Recording the Crime Scene Investigation</b> .....	<b>145</b>
1. Establish Crime Scene Debriefing Team .....	145
2. Perform Final Survey of the Crime Scene .....	146
3. Documentation of the Crime Scene .....	146
4. Acknowledge Specialized Crime Scene Circumstances .....	147
<i>Crime Scene Investigation in Correctional and Custodial Facilities</i> .....	148
<i>Time-Limited Crime Scene Investigation</i> .....	149
<b>E. Crime Scene Equipment</b> .....	<b>150</b>
1. Initial Responding Officer(s) .....	150
2. Crime Scene Investigator/Evidence Technician .....	151
3. Evidence Collection Kits (Examples).....	153
<b>F. Appendices</b> .....	<b>i</b>
Appendix A. Glossary.....	ii
Appendix B. Reference List.....	viii
Appendix C. Diagrams .....	x

## Acknowledgements

This updated Crime Scene Investigation: A Guide to Law Enforcement is a revision of the original publication published in January 2000, and borrows heavily from that work. The original publication was based upon the work of the National Crime Scene Planning Panel and additional Technical Working Group Members. Their contributions remain as vital today as when the original Guide was published.

To develop this expanded edition, a Review Committee of recognized experts was assembled. This committee selected additional material from content developed for Department of Justice–funded crime scene projects, Scientific Working Groups and other open-source documents, which are reflected in the Reference section. Additional vetting of the material was accomplished through recognized subject matter experts.

NFSTC wishes to thank the Bureau of Justice Assistance (BJA), the National Institute of Standards and Technology (NIST) and the National Institute of Justice (NIJ) for providing input to this project.

The resulting document includes detailed procedural guides for the complete range of crime scene investigation tasks – from securing the scene to submitting the evidence. This publication provides law enforcement professionals and first responders step-by-step guidance in this crucial first phase of the justice process.

Agencies are encouraged to use this reference to enhance existing training and promote quality. While these methods can be implemented at any agency, jurisdictions will want to carefully consider the procedures and their applicability to local agencies and circumstances.



# National Crime Scene Planning Panel (NCSPP)

*January 2000*

**Dr. José R. Almirall**, Associate Director/  
Assistant Professor  
International Forensic Research Institute  
Department of Chemistry  
Florida International University  
Miami, Florida

**Susan Ballou**, Forensic Scientist  
Montgomery County Police Department  
Crime Laboratory  
Rockville, Maryland

**Paul Carroll**, Sergeant (Ret.)  
Chicago Police Department  
Big Pine Key, Florida

**Elizabeth Farris**, Chief Trial Counsel  
Hampden County District Attorney's Office  
Springfield, Massachusetts

**Jo Ann Given**, ASCLD/LAB  
Naval Criminal Investigative Service  
Norfolk, Virginia

**Marjorie Harris**, Senior Forensic Scientist  
Department of Criminal Justice  
Division of Forensic Science  
Richmond, Virginia

**Larry McCann**, Senior Special Agent (Ret.)  
Virginia State Police  
Richmond, Virginia

**Dr. Joseph L. Peterson**  
Department of Criminal Justice  
University of Illinois  
Chicago, Illinois

**Elliot B. Spector**, Director  
Center for Police and Security Training  
Suffield, Connecticut

**Ann Talbot**, ASCLD/LAB  
Albuquerque Police Department  
Albuquerque, New Mexico

**James T. "Tom" Thurman**, Associate  
Professor  
College of Law Enforcement  
Eastern Kentucky University  
Richmond, Kentucky

# Additional Technical Working Group Members

**Hal R. Arenstein**, Attorney at Law  
Law Offices of Hal Arenstein  
Cincinnati, Ohio

**Dexter J. Bartlett**, Inspector  
Illinois State Police  
Crime Scene Services Command  
Joliet, Illinois

**Eric Buel**, Director  
Department of Public Safety  
Crime Laboratory  
Waterbury, Vermont

**Jeff Cover**, Supervisor  
Crime Scene Unit  
Anne Arundel County Police Department  
Millersville, Maryland

**Elizabeth Devine**, Supervising Criminalist  
Scientific Services Bureau  
Los Angeles County Sheriff's Department  
Los Angeles, California

**Henry Escobar**, Detective  
San Antonio Police Department  
San Antonio, Texas

**Jerry N. Estes**, District Attorney General  
10th Judicial District  
Athens, Tennessee

**James Estrada**, Detective Investigator  
Homicide Unit  
San Antonio Police Department  
San Antonio, Texas

**Drew Findling**, Attorney  
Atlanta, Georgia

**Nan Horvat/John Sarcone**  
Assistant Polk County Attorney/ Polk County  
Attorney  
Des Moines, Iowa

**N. Michael Hurley**, Regional Director  
Oregon State Police  
Forensic Services Division  
Springfield, Oregon

**Gary L. Kaldun**, Forensic Scientist, Crime  
Scene Coordinator  
Bureau of Criminal Apprehension  
St. Paul, Minnesota

**Joe Marchan**, Supervising Criminalist  
Texas Department of Public  
Safety Crime Laboratory  
McAllen, Texas

**Joseph John Moseley, II**, Detective  
Central Homicide Evaluation Support Squad  
Chicago Police Department  
Chicago, Illinois

**Robert Mullins**, Detective Investigative  
Services  
New Haven Police Department  
New Haven, Connecticut

**Steve Nash**, Detective  
Marin County Sheriff's Department  
San Rafael, California

**Kathryn Normington-Hollenbach**, Senior  
Forensic Scientist  
Wyoming State Crime Laboratory  
Cheyenne, Wyoming



**Galen Paine**, Assistant Public Defender  
Public Defender's Office  
Sitka, Alaska

**Michael J. Rafferty**, Chief of Forensics  
Florida Department of Law Enforcement  
Fort Myers Regional Operations Center  
Fort Myers, Florida

**Eugene Rifenburg**, Senior Investigator (Ret.)  
New York State Police Investigator (current)  
Oneida Nation Police  
Munnsville, New York

**Gary A. Rini**, Police Commander (Ret.)  
Director  
The American Institute for Police Science  
Elkhorn, Nebraska

**Heidi Robbins**, Supervising Criminalist  
Scientific Services Bureau  
Los Angeles County Sheriff's Department  
Los Angeles, California

**Darrell Ryan**, Lieutenant  
Nashville Police Department  
Nashville, Tennessee

**Norman Shapiro**, Vice President  
New York State Defender's Association  
Counselor at Law  
Law Offices of Norman Shapiro  
Middletown, New York

**Clarene Shelley**, Lieutenant  
Lakewood Police Department  
Lakewood, Colorado

**Gregory Smith**, Assistant County Prosecutor  
Office of the County Prosecutor  
Camden County  
Camden, New Jersey

**Richard Stanek**, Captain  
Minneapolis Police Department  
Minneapolis, Minnesota

**Brad Townsend**, Sergeant  
Corona Police Department  
Corona, California

**Larry Turner**, Director of Forensic Services  
Jackson Police Department Crime Laboratory  
Jackson, Mississippi

**Stephen Weichman**, County and Prosecuting  
Attorney  
Teton County  
Jackson, Wyoming

**James Wisser**, Crime Scene Investigator/  
Evidence Custodian  
Mount Pleasant Police Department  
Mount Pleasant, South Carolina

**Larry Wood**, Detective  
Major Case Unit  
Smyrna Police Department  
Smyrna, Georgia

**John Yarbrough**, Sergeant Homicide Bureau  
Los Angeles County Sheriff's Department  
Commerce, California

## Review Committee

**Gregory B. Bailey**, Evidence Technician  
(Ret.)  
Contract Assessor, Forensic Quality Services  
Berkley, Michigan

**Detective Brian Cochran**, Teaching  
Associate  
National Forensic Academy  
Boone County, Kentucky

**Robert C. Gaffney, CSCSA**  
Special Agent/Operations Officer  
Forensic Research and Training Division  
US Army Criminal Investigation Laboratory  
Forest Park, Georgia

**Lesley Hammer, D-ABC, CSCSA, CFWE**  
Forensic Examiner  
Hammer Forensics  
Anchorage, Alaska

**Joseph Heppler**, Computer Forensic Team  
Lead  
CACI Contractor for U.S. Dept of State  
Computer Investigations and Forensics  
Arlington, Virginia

**Mike James**, Assistant Sheriff (Retired)  
Orange County Sheriff's Department  
Orange County, California

**Gregory S. Klees**, Firearms and Toolmark  
Examiner  
Bureau of Alcohol, Tobacco, Firearms and  
Explosives  
Ammendale, Maryland

**Sgt. Jim Markey, M.Ed**  
Consultant/Trainer  
Investigative Lead, LLC  
Fountain Hills, AZ

**Cory Latham, CSCSA, CBPE**  
Teaching Associate  
National Forensic Academy  
Oak Ridge, Tennessee

**Wayne Moorehead, F-ABC, F-AAFS**  
Forensic Consultant  
forensicTRACE  
Rancho Santa Margarita, California

**Steve O'Dell, CSCSA, CBPE**  
Senior Police Advisor  
Senior Forensic Laboratory Management  
Advisor  
International Narcotics and Law Enforcement  
US Department of State  
Washington, DC

**Joseph L. Parker, D-ABFDE**  
Forensic Document Examiner  
Atlanta Forensic Document Examiner  
Services, Inc.  
Peachtree City, Georgia

**Rodney A. Schenck, CLPE, CFWE, CCSA**  
Physical Scientist, Forensic Latent Print  
Examiner  
U.S. Army Criminal Investigation Laboratory  
Expeditionary Forensic Division  
Forest Park, Georgia

**Elizabeth Thompson**, DNA Laboratory  
Director  
Orange County Crime Laboratory  
Orange County Sheriff-Coroner  
Orange County, California

# Crime Scene Investigation

## A Guide for Law Enforcement

### Section A

Arriving at the Scene: Initial Response/Prioritization of Efforts

### Section B

Preliminary Documentation and Evaluation of the Scene

### Section C

Processing the Scene

### Section D

Completing and Recording the Crime Scene Investigation

### Section E

Crime Scene Equipment

**Authorization:** Actions taken pursuant to this guide shall be performed in accordance with department policies and procedures and Federal and State laws.

This handbook is intended as a guide to recommended practices for crime scene investigation.

Jurisdictional, logistical, or legal conditions may preclude the use of particular procedures contained herein.

For potentially devastating situations, such as biological weapons or radiological or chemical threats, the appropriate agencies should be contacted. The user should refer to the National Institute of Justice's publications for fire and arson investigation, bomb and explosives investigation, electronic crime investigation, and death investigation where applicable.

## A.

## Arriving at the Scene: Initial Response/ Prioritization of Efforts

*Note: Words and phrases that are defined in the glossary appear in bold italics on their first appearance in the body of the Guide.*

### 1. Initial Response/ Receipt of Information



**Principle:** One of the most important aspects of securing the crime scene is to preserve the scene with minimal ***contamination*** and disturbance of physical evidence. The initial response to an incident should be expeditious and methodical.

**Policy:** The ***initial responding officer(s)***, upon arrival, shall assess the scene and treat the incident as a crime scene. They shall promptly, yet cautiously, approach and enter the crime scene, remaining observant of any persons, vehicles, events, potential evidence, and environmental conditions.

**Procedure:** The initial responding officer(s) should:

- a. Note or log dispatch information (e.g., address/location, time, date, type of call, parties involved).
- b. Be aware of any persons or vehicles leaving the crime scene.
- c. Approach the scene cautiously, scan the entire area to thoroughly assess the scene, and note any possible secondary crime scenes.
- d. Be aware of any persons and vehicles in the vicinity that may be related to the crime.
- e. Make initial observations (look, listen, smell) to assess the scene and ensure officer safety before proceeding.
- f. Remain alert and attentive. Assume the crime is ongoing until determined to be otherwise.
- g. Treat the location as a crime scene until assessed and determined to be otherwise.
- h. Safely direct additional responding units into the area.

**Summary:** It is important for the initial responding officer(s) to be observant when approaching, entering, and exiting a crime scene.

## 2. Safety Procedures

**Principle:** The safety and physical well-being of officers and other individuals, in and around the crime scene, are the initial responding officer(s)' first priority.

**Policy:** The initial responding officer(s) arriving at the scene shall identify and control any dangerous situations or persons.

**Procedure:** The initial responding officer(s) should:

- a. Ensure that there is no immediate threat to other **responders**; scan area for sights, sounds, and smells that may present danger to personnel (e.g., hazardous materials such as gasoline, natural gas). If the situation involves a clandestine drug laboratory, **biological weapons**, or **radiological** or **chemical threats** the appropriate personnel/agency should be contacted prior to entering the scene.
- b. Approach the scene in a manner designed to reduce risk of harm to officer(s) while maximizing the safety of victims, witnesses, and others in the area.
- c. Survey the scene for dangerous persons and control the situation.
- d. Notify supervisory personnel and call for assistance/backup.

**Summary:** The control of physical threats will ensure the safety of officers and others present.

## 3. Emergency Care

**Principle:** After controlling any dangerous situations or persons, the initial responding officer(s)' next responsibility is to ensure that medical attention is provided to injured persons while minimizing contamination of the scene.

**Policy:** The initial responding officer(s) shall ensure that medical attention is provided with minimal contamination of the scene.

**Procedure:** The initial responding officer(s) should:



- a. Assess the victim(s) for signs of life and medical needs and provide immediate medical attention.
- b. Call for medical personnel.
- c. Guide medical personnel to the victim to minimize contamination/alteration of the crime scene.
- d. Point out potential physical evidence to medical personnel, instruct them to minimize contact with such evidence (e.g., ensure that medical personnel preserve all clothing and personal effects without cutting through bullet holes, knife tears), and document movement of persons or items by medical personnel.
- e. Instruct medical personnel not to “clean up” the scene and to avoid removal or alteration of items originating from the scene.
- f. If medical personnel arrived first, obtain the name, unit, and telephone number of attending personnel, and the name and location of the medical facility where the victim is to be taken. In some instances, fingerprint and shoe impressions of medical personnel may need to be taken for elimination purposes.
- g. If there is a chance the victim may die, attempt to obtain “*dying declaration.*”
- h. Document any statements/comments made by victims, suspects, or witnesses at the scene.
- i. If the victim or suspect is transported to a medical facility, send a law enforcement official with the victim or suspect to document any comments made and preserve evidence. (If no officers are available to accompany the victim/suspect, stay at the scene and request medical personnel to preserve evidence and document any comments made by the victim or suspect.)
- j. Safeguard evidence, such as a weapon, that is taken into custody. Follow chain-of-custody procedures as soon as the evidence is confiscated.

**Summary:** Assisting, guiding, and instructing medical personnel during the care and removal of injured persons will diminish the risk of contamination and loss of evidence.

## 4. Secure and Control Persons at the Scene

**Principle:** Controlling, identifying and removing persons at the crime scene, and limiting the number of persons who enter the crime

scene and the movement of such persons is an important function of the initial responding officer(s) in protecting the crime scene.

**Policy:** The initial responding officer(s) shall identify persons at the crime scene and control their movement.

**Procedure:** The initial responding officer(s) should:

- a. Control all individuals at the scene—prevent individuals from altering/destroying physical evidence by restricting movement, location and activity while ensuring and maintaining safety at the scene.
- b. Identify all individuals at the scene, such as:
  - Suspects: Secure and separate.
  - Witnesses: Secure and separate.
  - Bystanders: Determine whether witness, if so treat as above; if not, remove from the scene.
  - Victims/family/friends: Control while showing compassion.
  - Law Enforcement, Medical and other assisting personnel.
- c. Exclude unauthorized and nonessential personnel from the scene (e.g., law enforcement officials not working the case, politicians, media).

**Summary:** Controlling the movement of persons at the crime scene and limiting the number of persons who enter the crime scene is essential to maintaining scene integrity, safeguarding evidence and minimizing contamination.

## 5. Boundaries: Identify, Establish, Protect and Secure

**Principle:** Defining and controlling boundaries provide a means for protecting and securing the crime scene(s). The number of crime scenes and their boundaries are determined by their location(s) and the type of crime. Boundaries are established beyond the initial scope of the crime scene(s) with the understanding that the boundaries can be reduced in size if necessary but cannot be as easily expanded.

**Policy:** The initial responding officer(s) at the scene shall conduct an initial assessment of the extent of the crime scene(s) and then establish and control its boundaries.

**Procedure:** The initial responding officer(s) should:

- a. Establish boundaries of the scene(s), starting at the focal point and extending outward to include:
  - Where the crime occurred.
  - Potential points and paths of exit and entry of suspects and witnesses.
  - Places where the victim/evidence may have been moved (be aware of *trace* and *impression evidence* while assessing the scene).
- b. Secure the scene. Set up physical barriers (e.g., ropes, cones, crime scene barrier tape, available vehicles, personnel, other equipment) or use existing boundaries (e.g., doors, walls, gates).
- c. Document the entry/exit of all people entering and leaving the scene, once boundaries have been established.
- d. Protect the scene. Control the flow of personnel and animals entering and leaving the scene to maintain integrity of the scene.
- e. Institute measures to preserve/protect evidence that may be lost or compromised (e.g., protect from the elements (rain, snow, wind) and from footsteps, tire tracks, sprinklers).
- f. Document the original location of the victim or any objects that you observe being moved.
- g. Consider search and seizure issues to determine the necessity of obtaining consent to search and/or obtaining a search warrant.

**Note:** Persons should NOT smoke, chew tobacco, use the telephone or bathroom, eat or drink, move any items from the scene including weapons (unless necessary for the safety and well-being of persons at the scene), adjust the thermostat or open windows or doors (maintain scene as found), touch anything unnecessarily (note and document any items moved), reposition moved items, litter, or spit within the established boundaries of the scene. Do not allow suspect to use bathroom facilities, or to alter his/her appearance, including brushing hair or washing hands.

**Summary:** Establishing boundaries is a critical aspect in controlling the integrity of evidentiary material.

## 6. Turn Over Control of the Scene and Brief Investigator(s) in Charge

**Principle:** Briefing the investigator(s) taking charge assists in controlling the crime scene, helps establish further investigative responsibilities and assists with the managing of resources.

**Policy:** The initial responding officer(s) at the scene shall provide a detailed crime scene briefing to the *investigator(s) in charge* of the scene.

**Procedure:** The initial responding officer(s) should:

- a. Brief the investigator(s) taking charge.
- b. Assist in controlling the scene.
- c. Turn over responsibility for the *documentation* of entry/exit.
- d. Remain at the scene until relieved of duty.

**Summary:** The scene briefing is the only opportunity for the next in command to obtain initial aspects of the crime scene prior to subsequent investigation.

## 7. Document Actions and Observations

**Principle:** All activities conducted and observations made at the crime scene must be documented as soon as possible after the event to preserve information.

**Policy:** The initial responding officer(s) shall maintain documentation as a permanent record.

**Procedure:** The initial responding officer(s) should document:

- a. Observations of the crime scene, including the location of persons and items within the crime scene and the appearance and condition of the scene upon arrival.
- b. Conditions upon arrival (e.g., lights on/off; shades up/down, open/closed; doors and windows open/closed; smells; ice, liquids; movable furniture; weather; temperature; and personal items.)
- c. Personal information from witnesses, victims, suspects and any statements or comments made.

- d. Their own actions and actions of others.

**Summary:** The initial responding officer(s) at the crime scene must produce clear, concise, documented information encompassing his or her observations and actions.

This documentation is vital in providing information to substantiate investigative considerations.

## 8. Establish a Command Post (Incident Command System) and Make Notifications

**Principle:** Setting up a location where crime scene investigation activities can be coordinated, media meetings can be held, and team meetings can occur is very valuable. This command post provides a central location for crime scene investigation activities and assessment of resources. The activities also relate to ensuring that other key investigative participants are told of the investigation and included in activities as needed.

**Policy:** The investigator(s) in charge shall set up a location where crime scene investigation activities can be coordinated, media meetings can be held, and team meetings can occur.

**Procedure:** The investigator(s) in charge should:

- a. Set up a temporary command post in a location where media can take necessary photographs without jeopardizing the scene (and evidence) security.
- b. Notify investigators or appropriate department(s) (such as Homicide) of information gathered at the crime scene. Discuss details of the scene during this step.
- c. Notify Communications Department (Dispatch) of phone numbers at the command post.
- d. Ask Communications Department (Dispatch) to notify surrounding agencies and send teletypes regionally and nationally when a suspect has fled the scene. These alerts should include a description of the suspect, vehicles involved and contact information for the person these agencies should contact if they locate the suspect.
- e. Brief the supervisor as required.

- f. Verify that a command post is established. If not, make the necessary arrangements to correct the situation.
- g. Debrief with first responder and officer(s)/investigator(s).
- h. Make necessary assignments, recording each on a formal assignment sheet.
- i. Use assignment sheet to record assignment updates throughout the investigation. Make this assignment sheet available to personnel working on the case. Assign evidence recorder, entry/exit recorder (who is also responsible for keeping event timetable).
- j. Ensure that the Communications Department is aware of important contact phone numbers including the command post.
- k. Establish the status and locations of victims and suspects.
- l. Establish the status of bulletins that have been broadcast regarding victims and suspects. Ensure that missing suspect alerts are broadcast. Establish a schedule for investigative team meetings (including all uniformed officers), during which status will be given, assignment updates will be made, and other key information will be shared.

**Summary:** The establishment of a command post is critical to the communication among the crime scene responders, Dispatch and others providing information to the crime scene responders.

## 9. Manage Witnesses

**Principle:** The timely interviewing of witnesses is crucial to the solution of a crime. Witnesses to crimes must be identified, secured, questioned at the scene, if applicable, and processed according to departmental regulations.

**Policy:** The investigator(s) in charge shall identify and secure witnesses to crimes, interview them at the scene, if applicable, and process them according to departmental regulations.

**Procedure:** The investigator(s) in charge should:

- a. Interview any witnesses at the scene separately to best use their reported experiences to benefit the overall investigation. Obtain written/recorded statements from each witness at the police station.
- b. Transport each witness to the police station separately from other witnesses or suspects.



- c. When possible, the following tasks should be performed by the Supervising Officer:
- Establish the status and locations of each victim and suspect.
  - Establish the status of bulletins that have been broadcast regarding each victim and suspect. Ensure that any necessary missing suspect alert is broadcast in a timely manner.

**Summary:** The timely separate interviewing of witnesses is important to obtain information about any crime.

## B.

## Preliminary Documentation and Evaluation of the Scene

### 1. Conduct Scene Assessment

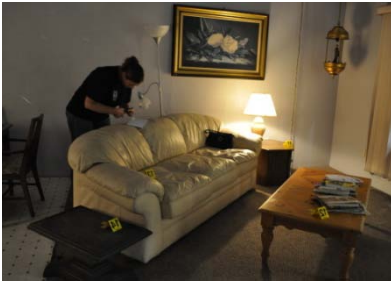

**Principle:** Assessment of the scene by the *investigator(s) in charge* allows for the determination of the type of incident to be investigated and the level of investigation to be conducted.

**Policy:** The investigator(s) in charge shall identify specific responsibilities, share preliminary information, and develop investigative plans in accordance with departmental policy and local, State, and Federal laws.

**Procedure:** The investigator(s) in charge should:

- a. Converse with the *first responder(s)* regarding observations/activities.
- b. Evaluate safety issues that may affect all personnel entering the scene(s) (e.g., *blood-borne pathogens*, hazards).
- c. Evaluate search and seizure issues to determine the necessity of obtaining consent to search and/or obtain a search warrant.
- d. Evaluate and establish a path of entry/exit to the scene to be utilized by authorized personnel.
- e. Evaluate initial scene *boundaries*.
- f. Determine the number/size of scene(s) and prioritize.
- g. Establish a secure area within close proximity to the scene(s) for the purpose of consultation and equipment staging.
- h. If multiple scenes exist, establish and maintain communication with personnel at those locations.
- i. Establish a secure area for temporary evidence storage in accordance with rules of evidence/*chain of custody*.
- j. Determine and request additional investigative resources as required (e.g., personnel/specialized units, legal consultation/prosecutors, equipment).
- k. Ensure continued scene integrity (e.g., document entry/exit of authorized personnel, prevent unauthorized access to the scene).

- l. Ensure that witnesses to the incident are identified and separated (e.g., obtain valid ID).
- m. Ensure the surrounding area is canvassed and the results are documented.
- n. Ensure preliminary **documentation**/photography of the scene, injured persons and vehicles.

**Summary:** Scene assessment allows for the development of a plan for the coordinated identification, **collection**, and preservation of physical evidence and identification of witnesses. It also allows for the exchange of information among law enforcement personnel and the development of investigative strategies.

## 2. Conduct Scene “Walk-Through” and Initial Documentation

**Principle:** The scene “**walk-through**” provides an overview of the entire scene, identifies any threats to scene integrity, and ensures protection of physical evidence. Written and photographic documentation provides a permanent record. A “walk-through” should only be completed if there will be no disturbing of evidence. There may be the need for the immediate documentation and collection of evidence prior to the walk through.

**Policy:** The investigator(s) in charge shall conduct a walk-through of the scene. The walk-through shall be conducted with individuals responsible for processing the scene.

**Procedure:** During the scene walk-through, the investigator(s) in charge should:

- a. Avoid contaminating the scene by using the established path of entry.
- b. Consider whether personal protective equipment (PPE) should be used.
- c. Prepare preliminary documentation (e.g. notes, rough sketches) of the scene as observed.
- d. Identify and protect fragile and/or perishable evidence (e.g., consider climatic conditions, crowds/hostile environment). Ensure that all evidence that may be compromised is immediately documented, photographed and collected.

- e. When involved in the initial walkthrough, note the condition of the scene. Record relevant observations, which may include things such as:
- Ceilings
  - Doors, including entry and exit points: Are they open, closed, locked or forced open? On which side was the key?
  - Windows: Are they open or closed? Is there broken glass? Were they locked or forced open?
  - Lights: On or off? If left on, which lights were on?
  - Shades or shutters: Open or closed?
  - Floors/Rugs
  - Interior lighting conditions
  - Odors: Cigarette smoke, gas, powder, perfume, etc.
  - Description of perpetrator (when present)
  - Description of crime-related people present
  - Description of emergency medical or search-and-rescue personnel present
  - Weapons observed
  - Furniture present, including location relative to victim, as applicable and overall scene
  - Signs of activity: Meal preparation, dishes in sink, condition of housekeeping (clean, dirty or items in disarray), appliances left on, television/stereo left on (note the channel), etc.
  - Date and time indicators: Mail, newspapers, dates on milk cartons, stopped clocks, spoiled foods, items that should have been hot or cold, but are at room temperature
  - Temperature of the room and environmental conditions
- f. Develop a general theory of the crime

**Summary:** Conducting a scene walk-through provides the investigator(s) in charge with an overview of the entire scene. The walk-through provides the first opportunity to identify valuable and/or fragile evidence and determine initial investigative procedures, providing for a systematic examination and documentation of the scene. Written and photographic documentation records the condition of the scene as first observed, providing a permanent record.

### 3. Note-Taking and Logs

**Principle:** Note-taking and logs provide a permanent record of crime scene activities.

**Policy:** All personnel assigned to the crime scene investigation shall maintain notes and logs of their activities.

**Procedure:** Detailed entry/exit logs should be created. An entry/exit log is used to document the people who come to and go from a crime scene during the investigation. People who were at the crime scene before the investigation began are also noted in this log.

- a. The officer monitoring the log, the “Log Officer,” is assigned the task by the Supervising Officer and is responsible for completing this task and monitoring the log at all times. The Log Officer is responsible for ensuring that the log is filled out thoroughly and anyone entering the scene has a stated purpose there.
- b. Position the log so that it is clearly visible. Set up the log for people to use when arriving to and departing from the scene. Record the following information about the crime scene:
  - Crime scene location
  - Name of witnesses
  - Name of victims
  - Name of persons taken into custody
  - Name of first responders and approximate arrival times
  - Name of Supervising Officer and approximate arrival time (approximate time should be used if arrival time was before the log was established)
- c. Record the information below for each person at the scene. If not using an *official log book or forms*, leave spaces where this information can be recorded:
  - Arrival date
  - Time of arrival
  - Name
  - Identification and Unit numbers
  - Organization (if not with the investigating department)
  - Reason for being at the scene

Log information should include:





# C Processing the Scene

## 1. Determine Team Composition

**Principle:** It is essential to a successful investigation to select a team of trained personnel to perform scene processing, based on the type of incident and complexity of the scene.

**Policy:** The investigator(s) in charge shall assess the scene to determine team composition and specialized resources required.

**Procedure:** Following the walk-through, the investigator(s) in charge should:

- a. Assess the need for additional personnel. They should be aware of the need for additional personnel in cases involving **multiple scenes**, multiple victims, numerous witnesses or unique circumstances.
- b. Assess forensic needs and call forensic specialists to the scene for expertise and/or equipment.
- c. Ensure that scene security and the entry/exit documentation are continued.
- d. Select qualified person(s) to perform specialized tasks (e.g., photography, sketch, **latent prints**, evidence collection).
- e. Document team members and assignments.

**Summary:** The assessment of the scene(s) determines the number of personnel and how responsibilities will be assigned.

## 2. Ensure Contamination Control

**Principle:** Contamination control and preventing **cross-contamination** at single or multiple scenes is essential to maintaining the safety of personnel and the integrity of evidence.

**Policy:** The investigator(s) in charge shall require all personnel to follow procedures to ensure scene safety and evidence integrity.

**Procedure:** Other responders and/or team members should:



- a. Limit scene access to people directly involved in scene processing.
- b. Follow established entry/exit routes at the scene.
- c. Identify first responders and consider collection of ***elimination samples***.
- d. Designate a secure area for trash and equipment.
- e. Use ***personal protective equipment*** (PPE) to prevent contamination of personnel and minimize scene contamination.
- f. ***Clean/sanitize*** or dispose of tools/equipment and personal protective equipment between each item of evidence collection and/or scenes.
- g. Utilize ***single-use equipment*** when performing direct collection of biological samples.

**Summary:** Minimize contamination by being safe, clean and careful to ensure the welfare of personnel and the integrity of the evidence.

### 3. Documentation

**Principle:** An assessment of the scene determines what kind of documentation is needed (e.g., photography, video, sketches, measurements, notes).

**Policy:** The investigator(s) in charge shall ensure documentation of the scene.

**Procedure:** The team member(s) should:

- a. Review the assessment of the scene to determine the type of documentation needed.
- b. Coordinate photographs, video, sketches, measurements and notes.
- c. Photograph (see ***Photography*** section for details):
  - Scene utilizing overall, medium, and close-up coverage.
  - Evidence to be collected with and without ***measurement scale*** and/or ***evidence identifiers***.
  - Victims, suspects, witnesses, crowd and vehicles.
  - Additional perspectives (e.g., aerial photographs, witness's view, area under body once body is removed).

- d. Record video as an optional supplement to photographs
- e. Prepare preliminary sketch(es) and measure:
  - Immediate area of the scene, noting case identifiers and indicating north on the sketch.
  - Relative location of items of evidence, correlating evidence items with evidence records.
  - Evidence prior to movement.
  - Rooms, furniture or other objects.
  - Distance to adjacent buildings or other landmarks.
- f. Generate notes at the scene:
  - Document location of the scene, time of arrival and time of departure.
  - Describe the scene as it appears.
  - Record *transient evidence* (e.g., smells, sounds, sights) and conditions (e.g., temperature, weather).
  - Document circumstances that require departure from usual procedures.

## Sketching

### *Equipment Needed*

- Graph paper
- Paper
- 50- to 100-foot retractable measuring tape
- 1000-foot walking wheel
- Folding rule
- Ruler
- Oversize clipboard with storage pocket
- Eraser
- Magnetic compass
- Personal protective equipment (when needed)
- Flashlight
- Notebook
- Pencil

The accuracy of all measuring devices should be ensured by comparison to a measure of certified accuracy, such as a NIST traceable ruler.

### ***General Considerations***

- A sketch of a crime scene is required when spatial relationships or proportional measurements are needed. Use spatial relationships to relate evidence to other objects. Use proportional measurements to calculate such things as bullet trajectory angles or to reconstruct accident details.
- The rough sketch is the first sketch drawn at the scene; multiple rough sketches may be required depending on the crime. The sketch includes a scene outline with the location of objects and evidence clearly marked. A finished sketch is derived from the rough sketch.
- Draw the rough sketch before anything is moved or destroyed, and after photographs are taken. Do not alter the scene.
- Depending on the crime, draw one or all of these types of sketches: a sketch showing the surrounding areas, a sketch showing only measurements, and a sketch showing locations of objects, such as the locations of evidence, victim(s), etc.
- Measurements should be accurate to within 1/4".
- Include, outside of the drawn crime scene, measurements for dimensions of rooms, furniture, doors and windows, and distances between objects, entrances and exits, bodies and persons. Draw details, such as object size, proportionally in a rough sketch.
- Take measurements from fixed location reference point, such as walls or curbs, or from stationary appliances.
- Include as much information as possible in the sketch: streets, plants, entry and exit points, location of bullets and cartridges, etc.
- Do not alter a rough sketch after leaving the crime scene. If changes are required of the rough sketch, photocopy the original rough sketch to preserve its integrity.
- Newer technology makes use of laser scanning devices to perform crime scene sketching. The employment of these devices should be reserved to investigators trained in their use.

### ***Information That Should be Documented***

- Record the time, date, name of the person who contacted the authorities, and incident information as soon as notification of a crime is received. These notes should be kept separate from the sketch.

- Initial notes about the incident should answer the who, what, when, where, why and how questions.
- Incident information includes: who reported the incident, when the incident was first reported, the crime scene location, a description of incident and participant names.
- Gather information to use when sketching by talking to others at the scene. Record that information in the notes.
- Questions that can provide valuable information include:
  - How did the victim or suspect arrive at or leave from the scene?
  - How was the crime committed?
  - Which items were handled?
  - Which items were moved?
  - Which items are broken or stained?
- Have potentially flammable vapors been detected at the scene? (When potentially flammable conditions exist, take appropriate precautions.)
- While sketching the scene, record related information in the notes. It is critical to use a systematic approach to note-taking while sketching to maintain a record of your activities and the order of sketches made.
- Specify the changes made to a scene prior to sketching, such as when objects were moved or placards added. Note who made the changes and why they occurred.

### ***Determining the Scale***

Determine the scale to use for all sketches. The usual scale for outdoor scenes is one inch equals twenty feet. The usual scale for indoor scenes is one-eighth inch equals one foot. Select which standard units of measurement will be used: metric (meters, centimeters) or English (feet, inches).

An important consideration when determining the scale is fitting the scene to the sketch paper. To calculate the scale:

1. Determine the longest measurement at the scene.
2. Divide this measurement by the longest measurement of the sketch paper. The resulting number establishes the largest measurement end of the scale.

3. Often graph paper is used for scale drawings. When using graph paper, assign a specific number of squares to the measurement identified in Step 2.
- Use this method to establish other measurements by substituting the actual measurement in place of the longest measurement in Step 1.
  - Create a title block on the graph paper being used for the sketch in the lower right corner of the paper. The title block typically includes:
    - Case number
    - Crime type
    - Victim name
    - Name and ID# of sketcher
    - Name and ID# of person verifying measurements
    - Location of sketch
    - Date completed
  - Create a legend for the sketch on the graph paper used for the sketch. Each sketch must include a legend that is specific to it. A legend identifies:
    - North-facing direction (usually points to top of page)
    - Identification symbols used for information in sketch
    - Sketch ID#
    - Scale used
  - An accepted practice for assigning identification symbols is:
    - Use compass points to identify walls.
    - Use evidence numbers assigned to objects to identify them in the sketch.
  - The legend will be updated after drawing the sketch to ensure accuracy and completeness, and to include:
    - Measurements for dimensions of rooms, furniture, doors and windows
    - Distances between objects, entrances and exits, bodies and persons

### ***Categories of Sketches***

There are four categories of sketches:

**Perspective** – A perspective sketch contains a vanishing point and depicts objects of evidence as they would appear to the eye with reference to relative distance and depth.

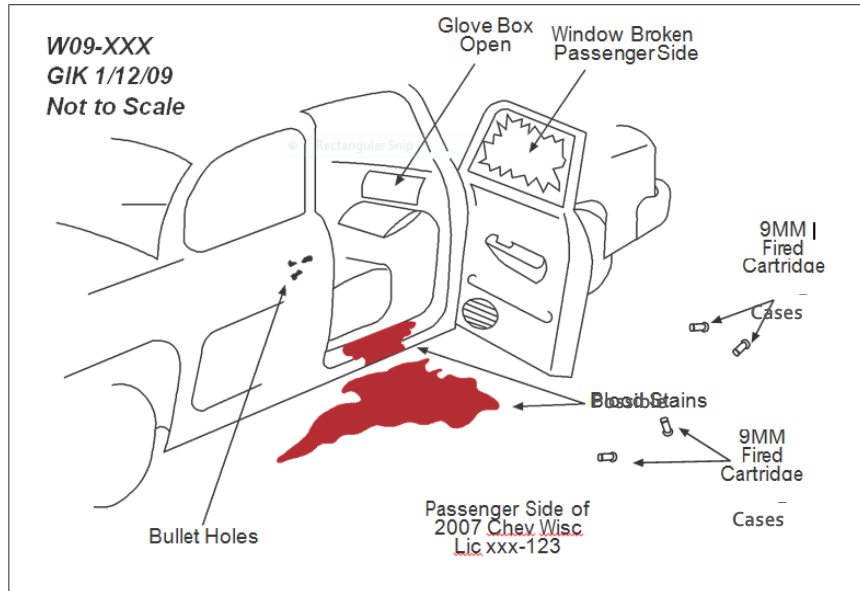

*Figure C-1. Perspective sketch of vehicle homicide scene*

**Projection** – A projection sketch usually contains only one viewpoint and depicts objects on one plane. The overview sketch (of the horizontal plane) is the most common type of sketch and is usually done from a bird’s eye view; it shows the floor plan. Less common is the elevation sketch (of the vertical plane), which shows a side view typically of landscapes or buildings.

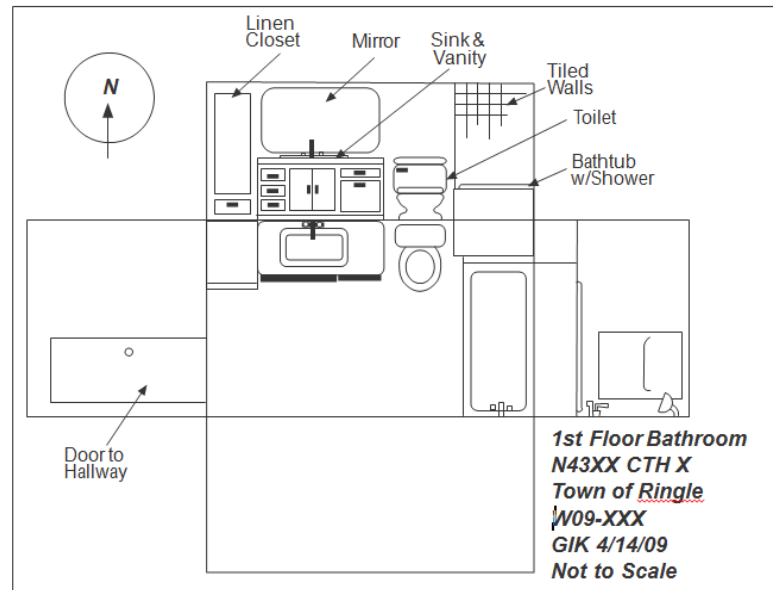

*Figure C-2. Projection sketch of bathroom*



One extrapolation of the projection sketch is the “Exploded” view sketch that contains more than one wall from one viewpoint. It combines the overview and elevation sketches.

**Schematic** – The schematic sketch is used when it is desirable to represent a sequence of events such as following the trajectory of a bullet through a crime scene location.

**Detailed** – The detailed sketch is used when describing a small area that is not easily incorporated into the overall drawing due to the scale chosen for the rough or finished scale drawing. This is especially useful for large crime scenes.

### ***Creating a Projection Sketch***

1. Determine the view to be shown in the sketch: overhead or exploded.
  - The overhead view shows a floor plan. This is the most frequently used view in sketches.
  - The exploded view shows a floor plan with walls laid out flat. Objects on the floor and on walls, such as bullet holes or bloodstains, are shown in their relative positions in the exploded view sketch.
2. Draw an outline that is to scale of the area of interest, including locations of approaches and accurate measurements of the perimeter. The size of the outline should fill as much of the paper as possible.
3. Draw the rough sketch before anything is moved or destroyed, and after photographs are taken. Do not alter the scene. Show locations of windows and doors. Use a curved line to indicate the direction that each door opens.
4. Use only the selected units of measurement. The sketch or accompanying notes should indicate where a measurement of an object was taken (e.g., middle of the object, near-corner, far-corner, etc.). Measurements of bloodstains are often done on a metric scale (e.g., millimeters).
5. Whenever possible, have another officer or crime scene investigator observe measurements for confirmation purposes.

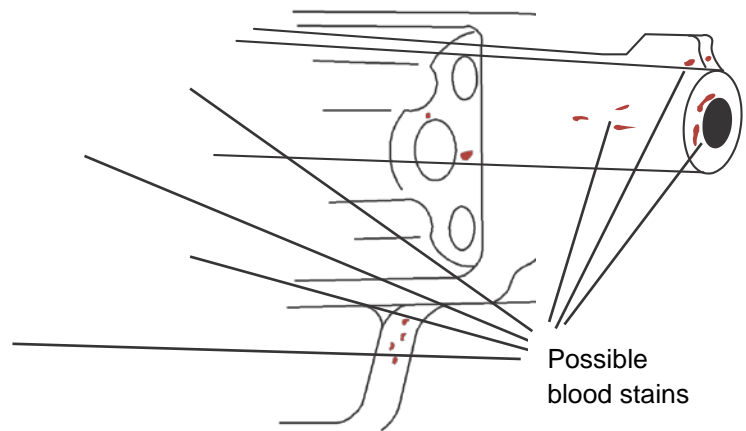

*Figure C-3. Detailed sketch of handgun indicating areas of possible blood stains*

There are four measuring techniques used to obtain accurate measurements for the sketch:

**Triangulation Method** – The triangulation method utilizes two fixed permanent objects within the crime scene. Measurements are taken from each fixed point to each piece of evidence.

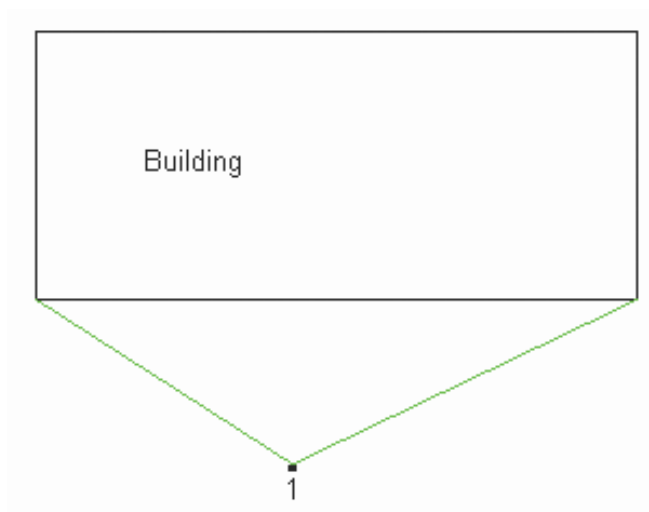

*Figure C-4. Triangulation method of measurement*

**Rectangular Coordinate Method** – The rectangular coordinate method is used when measuring the distance to an object from two mutually perpendicular objects, such as walls that meet at a 90-degree angle.

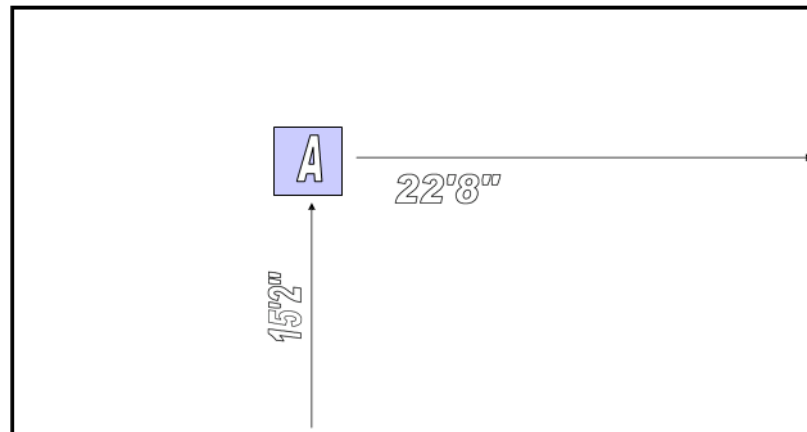

*Figure C-5. Rectangular coordinate method of measurement*

**Polar Coordinate Method** – The polar coordinate method is more appropriate for an outdoor scene in which only a single fixed or reference point is present. Measure both the distance and direction (angle) an object is from a known reference point. The angle can be measured with either a large protractor or an optical device such as a transit or a compass. The protractor technique with a 360-degree protractor is useful for underwater scenes.

**Transecting Baseline Coordinate Method** – The transecting baseline coordinate method is used to measure items of evidence when there are numerous objects in the crime scene and other measuring techniques will not work. This is accomplished by laying a tape measure down so that it crosses the entire room or area to be measured. This first tape measure becomes the baseline for all other measurements in the crime scene. Measurements are then made perpendicularly from this tape by laying another tape measure at a 90-degree angle to the first tape and measuring out to the evidence.

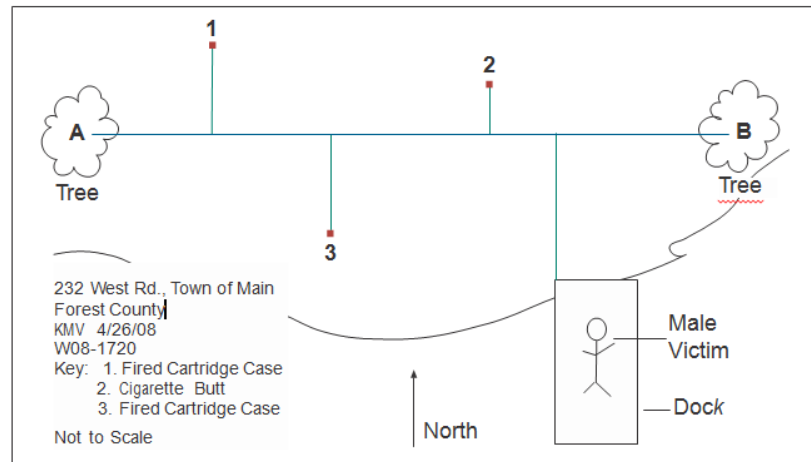

*Figure C-6. Transecting baseline coordinate method of measurement*

6. Take accurate measurements of the exact locations and relative positions of evidence using the triangulation method when there are at least two fixed points within the outlined area.
7. Use triangulation indoors or outdoors; it is an especially good method to use in areas lacking straight lines.
8. Take measurements from fixed locations, such as a wall or curb, or from a stationary appliance. Identify these locations in your legend.
9. Measurements should be accurate to within  $\frac{1}{4}$  inch.
10. Include height measurements to show how far off of the ground an object was found.
11. When determining distance based on triangulation:
  - a) Select two fixed points within the outlined area, such as walls, curbs, or street signs.
  - b) Draw a baseline between the two fixed points.
  - c) Select another object within the outlined area.
  - d) Measure the distance to that object from each of the baseline's fixed end points, creating a triangle.
12. Use a measuring tool to ensure accurate measurements are taken.
13. Take accurate measurements of the exact location and relative position of evidence using rectangular coordinates and the baseline method when: there are two known points or accurate measurements are needed for an object located

- on or perpendicular to the line between those two points (the baseline).
14. Use the baseline method in outdoor areas that are irregularly shaped and where no natural baseline is present. This method is useful in situations such as scenes that occur in the desert or on farmland.
  15. Take measurements from fixed locations, such as a lamp post or curb, or from a stationary appliance.
  16. Measurements should be accurate to within  $\frac{1}{4}$  inch.
  17. Include height measurements to show how far off of the ground an object was found.
  18. When determining distance based on the transecting baseline coordinate method:
    - a) Select two fixed points within (at the outer edges of) the outlined area, such as a kitchen appliance, a door, a window, a corner or wall (a wall is preferred).
    - b) Create the baseline by drawing a line between the two selected fixed points.
    - c) Measure the length of the baseline.
    - d) Select an object within the outlined area.
    - e) When the object is on the baseline, measure from one of the fixed end-points to the object.
    - f) When the object is not on the baseline, draw a straight line from the object at a 90-degree angle to the baseline.
    - g) Measure the length of the line drawn.
    - h) Measure from one of the fixed end-points to the point where the new line meets the baseline.
  19. When a sketch is complete, prominently write “Not to Scale” outside of the sketch, then update related documentation, such as the legend and notes. Note: Although accurate measurements were taken, potential courtroom controversies related to those measurements may be avoided by placing the “Not to Scale” disclaimer on the rough sketch.
  20. Ensure that all identification symbols used on the sketch are included and defined on the legend.
  21. Include descriptive details related to the sketch in notes such as lighting conditions, names of people in the area, colors of objects, odors, weather.

22. Include updates such as distances between objects and dimensions of rooms, windows, doors, etc.
23. Until all rough sketches for a crime scene are complete, repeat the previous steps.
24. Do not update any rough sketch after leaving the scene.
25. Finish note-taking at the scene. Include the time that sketching was completed in the notes. Note-taking should occur throughout the sketching activities.
26. Finished sketches can be completed either by the originator of the rough sketches or by another staff member, such as a draftsman or artist.



Courtesy of Scott Campbell

### Photography

Common crime scene investigation photography is an important part of the documentation of a crime scene. Photographs are typically taken based upon the perspective of the camera to the target.

- a. Overall
- b. Midrange
- c. Close-up

**Note:** Videography is discussed on page 35.

### *Equipment Needed*

- Personal protective equipment
- Camera: 35mm and/or digital single-lens reflex (SLR) of 12 megapixels or greater recommended (a backup camera is also advisable)
- Several rolls of color film and black-and-white film, if using film camera
- Battery backups
- Memory cards for digital cameras
- Detachable flash or additional lighting
- Flashlight
- Tripod
- Camera cleaning supplies
- Pen
- Notebook
- Evidence placards
- Rulers

### ***General Considerations***

- Always use the designated safe route when moving through the scene. Avoid disturbing the scene.
- When it is necessary to alter the scene, such as by placing placards or disassembling equipment, always take photographs of the scene before and after alteration, and with scale when appropriate.
- When using a digital camera, never delete a photograph from camera or digital media memory. When using film, never discard used film or negatives.
- Use a sturdy tripod with a cable release or the camera timer feature when placing the camera 90 degrees to the subject, such as when taking fingerprint/footprint/shoeprint/tire track photos.
- Take interior photographs using a vertical orientation to get the full length of a wall in a photograph.
- Take a complete set of pictures, including overall (long-range), midrange and close-ups.
- Remove the film or download the digital images and store in a secure location according to departmental regulations when photography is completed.

### ***Preliminary Steps***

1. Upon arrival at the scene, record names and arrival times (when known) of all personnel involved, including investigators, medics, first responders, etc.
2. When applicable, include the names of those assigned to specific tasks in either the photo log or, when using a photo list, a notebook.
3. Plan the photography route. Photograph transient objects, such as bloodstains or latent prints, as soon as possible. Move from the exterior to the interior of the crime scene, and from general to specific focus.
4. The photography session should occur in an uninterrupted, systematic, focused manner. When planning the route, ask:
  - How did the victim or suspect arrive at or leave from the scene?
  - How was the crime committed?
  - Which items were handled?
  - Which items were moved?



- Which items are broken or stained?
- Have potentially flammable vapors been detected at the scene?

**Caution:** Some photographic and flash equipment is flammable. When potentially flammable conditions exist, appropriate precautions must be taken.

**Note:** Do not go beyond boundary markers to take photographs unless absolutely necessary.

5. Plan and prepare lighting for each scene and camera angle. The following techniques are commonly employed:
  - a) Front lighting places the camera, lens, and flash or light source, directly in front of the object to be photographed. It is often the most appropriate type of lighting to use at crime scenes.
  - b) Side or oblique lighting places the camera directly in front of the object while the flash or light source is placed to the side of the object to be photographed. This can range from 45 to 90 degrees depending on the subject and the shadow detail observed. Oblique lighting produces the best results for three-dimensional (3D) objects and is recommended for the following:
    - To show details such as tool marks, surface irregularities or textures
    - To show vehicle accident damage
    - When photographing in closets or other small spaces
    - When photographing polished surfaces
6. Control the use of lighting by manually changing the aperture, shutter speed settings and turning on/off flash settings. It is important to have a detachable flash, or, if the flash is not detachable, another light source.

### ***Film Photography***

Most agencies no longer use film for crime scene photography. If film is used, consider the following guidelines:

- Plan the type of film to be used for a series of photographs when anticipating taking midrange then close-up photographs immediately after overall photographs.

- If it is anticipated that a change of film will be necessary, change the film before taking the overall photographs.
- **Black-and-white film:** Use black-and-white film for close-up photographs of fingerprint/footprint/shoeprint/tire track evidence.
- **Color film:** Use color film for close-up photographs of bloodstains and other bodily fluids.



### **Overall Photographs**

- Take overall photographs of the area surrounding the scene from its perimeter, from multiple locations and angles. Include exteriors of buildings, cars, both sides of entries and exits, and bystanders.

Overall photographs should:

- Encompass the entire large scene and be overlapping
  - Represent a 360-degree perspective and include a landmark
  - Include identifying marks, such as house number(s) or license plate(s)
- Overall photos may also encompass smaller “sub-scenes” that exist within the larger scene. For indoor scenes, consider photography from each corner of a room, looking into the room.
  - After the scene is photographed as found, additional photographs with placards, used as evidence identifiers, must be wholly visible in overall photographs when they are used, such as when midrange and close-ups will be taken of the scene. They must be placed in close proximity to the subject(s) of the photograph.
  - While taking photographs of a scene, record related information in notes.
  - It is critical to use a systematic approach to note-taking while taking photographs to maintain a record of your activities and the order and location of pictures as they are taken.
  - Specify the changes you made to a scene while taking photographs, such as when a light was turned on or objects were moved.
  - Note-taking should occur throughout the photography session. Finish note-taking at the scene. Include the time that photographing began and was completed in the notes.



Courtesy of Rebecca Carter

### ***Midrange Photographs***

- Take midrange photographs before and after placing placards or rulers. It is important to take photographs that establish the relationships of objects or reference points in the scene.
- Take close-up photographs immediately after taking the midrange photograph, when appropriate.
- It may be appropriate to follow midrange photographs of a scene with close-up pictures of the same scene when showing a scene before, during, and after placard/ruler placements, near-views of human injuries or vehicle accident damage.
- While taking photographs of a scene, record related information in notes.
- Take photographs of transient evidence from a position that:
  - Shows the spatter relative to other objects in the area
  - Is perpendicular to the spatter
- Take pictures of the scene before and after placing the placards and rulers, and after removing the placards and rulers.

### ***Photographing the Deceased***

Before the body of a deceased person is moved, it should be photographed. The following guidelines should be followed:

- Take photographs from all possible angles. Show a facial view, and the positions of the hands and feet when possible to do so without altering the body, its clothing or position. Wound photography should be conducted at close-up range.
- Take photographs while moving around the body and from an overhead perspective. Photograph the body from two perspectives, when possible:
  - a) As though looking at the body from a standing position
  - b) From the same level as the body is lying, such as at ground level when the body is lying on the ground
- Use oblique lighting to show wounds on the body, such as bite marks, with and without a scale.
- After the deceased has been removed from the scene, photograph the area where the body was.
- Signs of activity can include:
  - TV and room lights turned on

- A glass holding a cold beverage (ice melting or still frozen) and a plate with fresh food on it
  - Scattered clothing, magazines, or other objects
  - A landline phone that was in use and is making a loud notification sound
  - Misplaced furniture, as with a tipped stool beside a body
  - Cigarettes, lit or remains piled in ashtray
  - Tool marks in unusual location or near entry/exit
  - Shoeprints and/or fingerprints
  - Drug paraphernalia
- Include the time that photographing was begun and completed in the notes.
  - Remove the film or download the digital images and store in a secure location according to departmental regulations.



Courtesy of Rebecca Carter

### ***Close-up Photographs***

- Photograph fingerprint/footprint/shoeprint/tire track evidence using black-and-white film (when using film). Carefully place the ruler and camera perpendicular to each other and relative to the impression.
- When the photograph needs to be accurately scaled:
  - The ruler must be on the same plane as the impression.
  - The camera lens must be perpendicular (90 degrees) to the subject.
  - Use a level and tripod to position the camera accurately.
- Take multiple shots with the light or flash at different angles, such as 0 degrees, 15 degrees, 45 degrees, etc., to achieve the best possible photographs.

### **Taking Photos of Impression Evidence**

**Tire Impressions:** For tire impressions, take a series of overlapping photographs showing the tire's entire circumference.

**Impressions on Glass:** When the impression is on glass and when possible:

- Protect latent prints
- Position a colored card or piece of cloth that contrasts with the impression behind the glass

- Include in notes that this approach was used for contrast purposes to obtain the photograph

**Impressions on a Mirror:** When the impression is on a mirror, hold the flash to the side (oblique lighting); use a tripod to avoid being in the photograph.

**Dust Impressions:** When photographing a dust impression or an impression in a soft material (e.g., wax or putty), use reflective lighting (also known as oblique lighting). When using reflective lighting, if detail does not appear sufficiently, block the ambient light and then experiment with positioning the light or flash in other locations until the desired result is achieved.

**Impressions on a Porous Surface:** When the impression is on a *porous surface*, position the light or flash wherever the best results or contrast can be achieved, such as at a 90-degree angle from the impression.

Photograph **bloodstains** or other bodily fluid stains using color film or digital camera. Carefully place the camera plane perpendicular to the plane of the stain and ruler. Stay alert to the location of the bloodstains, so equipment isn't inadvertently touched to the stain.

- It is extremely important that the ruler be on the same plane as the impression.
- If the stain is on a wall, use an adhesive label with a ruler on it. Otherwise, tape a ruler beside the stain, or have an assistant hold the ruler beside the stain. Indicate upward direction.
- Ensure that the camera lens is perpendicular (90 degrees) to the subject. Adjust lighting when photographing the stain to obtain the best contrast and result.
- When the stain is on glass, position a colored card or piece of cloth that contrasts with the stain behind the glass, making sure to protect latent prints; include in the notes that this approach was used for contrast purposes to obtain the photograph.
- When the stain is on a mirror, hold the flash off to the side (oblique lighting) and use a tripod to avoid being in the photograph. The camera will show in the photograph when the mirror is 90 degrees from the lens.



Courtesy of Scott Campbell

### ***Additional Techniques for Close-up Photography***

If not using a digital camera, photograph wounds using color film. Carefully place the camera perpendicular relative to the wounds to



obtain accurate measurements. Photograph the body of a deceased person before moving it and also photograph it at the morgue. Include scales where appropriate.

- Adjust lighting when photographing the wounds to obtain the best contrast and result. Take multiple shots with the light held or placed at different angles to the subject in order to achieve the best results.
- Retake photographs of wounds such as bruises at different intervals to capture changes, such as in color, over several days.

Photograph serial numbers on weapons or VIN numbers on vehicles:

1. Carefully place the ruler, camera and placard relative to the item to obtain accurately scaled photographs.
2. Place placard and ruler on the same plane as the weapon. It is extremely important, when the photo needs to be accurately scaled, that the ruler be on the same plane as the subject. The camera lens should be perpendicular (90 degrees) to the subject.
3. Position the lighting to obtain the best possible contrast and results. Take multiple shots with the light held or placed at different angles to the subject in order to achieve the best results.
4. Photograph vehicular damaged areas, the license plate and the registration decal.
5. Include the time that photographing was begun and completed in the notes.
6. Remove the film or download the digital images and store in a secure location according to departmental regulations.

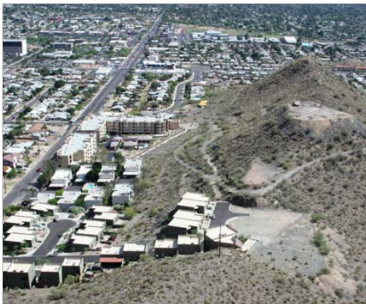

### ***Aerial Photographs***

- Take aerial and/or overhead photographs of a scene to show geographic relationships of locations or objects and aid identification of objects shown in other photographs.
- Obtain aerial photographs by taking the pictures from a helicopter or plane. News footage can sometimes be a useful source of aerial photographs.
- Overhead photographs, in this context, are taken from above the scene, such as from a ladder, a second story, a cherry picker; they are not taken from the sky, as from a plane.
- Aerial and overhead photographs must be overlapping.

- Remove the film or download the digital images and store in a secure location according to departmental regulations.

## Videography

### *Equipment Needed*

- Video camera
- Video kit with battery and recording media
- Personal protective equipment
- Additional sources of lighting
- Camera cleaning supplies
- Tripod
- Pen
- Notebook

### *General Considerations*

- Plan the video shoot carefully. Take video of the scene in its original state from multiple angles and distances. Take video of fragile evidence first.
- Avoid disturbing the scene. Always take video of the scene before and after alteration, such as when placards and scales are placed near evidence.
- Exclude officers, bystanders, and others at a scene from the video. Turn audio off.
- Take overall (long-range) video to show where the crime occurred, midrange video to show relationships of evidence and other points of interest, and close-up video to show individual items and their characteristics.
- Use a sturdy tripod whenever possible to reduce movement while taking video. Take video from angles that result in the best representation of that scene. Avoid panning side to side or up and down. Avoid zooming while out of focus.
- Always use the designated safe route when moving through the scene.
- When applicable, include the names of those assigned to specific tasks in your notebook.
- Plan the videography route. Take video of transient objects, such as bloodstains or latent prints, as soon as possible. Move from the exterior to the interior of the crime scene, and from general to specific focus.



- The videography session should occur in an uninterrupted, systematic, focused manner. When planning the route, ask:
  - How did the victim or suspect arrive at or leave from the scene?
  - How was the crime committed?
  - Which items were handled?
  - Which items were moved?
  - Which items are broken or stained?
  - Have potentially flammable vapors been detected at the scene?

*Caution:* Some equipment is flammable. When potentially flammable conditions exist, appropriate precautions must be taken.

- Go beyond boundary markers to take video only when necessary.
- Plan and prepare lighting for each scene and camera angle.
  - a) Front lighting places the camera lens at a 90-degree angle to the recorded object. It is often the most appropriate type of lighting to use at crime scenes.
  - b) Side lighting places the lighting source at a 45-degree angle to an object. It is used:
    - to show details such as tool marks, surface irregularities or textures
    - to show vehicle accident damage
    - when videotaping in closets or other small spaces
    - when videotaping polished surfaces
- Control the use of lighting by manually changing the focus settings and turning on/off flash settings.
- It is important to have a detachable flash or, if the flash is not detachable, another light source.
- Turn audio off.
- Record overall video of the house/building exterior, vehicles, other structures at the crime scene, including entrances and exits, and bystanders. Slowly pan in one directional sweep; never move the camera side to side or up and down.

- Overall video should include a 360-degree view of the entire scene including landmarks, entrances and exits, and identifying marks, such as a house number or license plate.
- Always use slow camera movements such as when panning and zooming.
- Use a tripod whenever possible, unless using it will disturb either the scene or other team members.
- When recording a long, narrow area, such as a side yard or train tracks, use a tripod and slow zooming. Always avoid walking while taping these shots
- Record entry/exit points from all possible angles. Show any paths used during the crime, when possible.
- While taking video of a scene, record related information in notes. Specify any changes made to a scene while taking video, such as when a light was turned on or the tripod left a mark.
- Film midrange and close-up exterior video (within 5 feet of subject) immediately following the overall recording of a scene.
- Record in a systematic, focused way.

When recording video:

- Use slow camera movements such as when panning and zooming. Before zooming, stop filming, zoom, focus, then start the filming.
  - Use the tripod whenever possible.
  - When recording a long, narrow area, such as a side yard or train tracks, use a tripod and slow zooming unless using it will disturb either the scene or other team members. Always avoid walking while recording a long, narrow area.
  - A high camera angle, such as with an overhead view, may be required to show individual objects that are on similar planes.
  - Record entry/exit points from all possible angles. Show any paths used during the crime.
- Move to the **interior** and take overall, midrange, and close-up video. When recording interiors:
- Always use slow camera movements such as when panning and zooming.

- Use a tripod whenever possible, even though it takes more time to set up, unless using it will disturb either the scene or other team members.
  - When recording overall video in tight spaces, such as closet or bathroom, use a high camera angle from a corner.
  - When recording a long, narrow area, such as a hallway or porch, use a tripod and slow zooming. Always avoid walking while recording these shots.
  - When necessary and possible, use artificial lighting to get the best possible clarity.
  - Consider using a blue filter over artificial light to achieve similar lighting as daylight.
- Complete note-taking. Include in the notes such items as events that occurred while recording and the time recording was completed.
- Remove the videotape from the camera or download the digital video before storing the camera in a secure location according to departmental regulations.

**Summary:** A well-documented scene ensures the integrity of the investigation and provides a permanent record for later evaluation.

## 4. Prioritize Collection of Evidence

**Principle:** The collection of evidence must be prioritized to prevent loss, destruction, or contamination.

**Policy:** The investigator(s) in charge and team members shall determine the order in which evidence is collected.

**Procedure:** The team member(s) should:

- a. Identify roles of the team members (e.g., scribe, collector, packager, etc.)
- b. Conduct a careful and methodical evaluation considering all physical evidence possibilities (e.g., *biological fluids*, latent prints, *trace evidence*).
- c. Focus first on the easily accessible areas in open view and proceed to out-of-view locations.

- d. Select a systematic search pattern for evidence collection based on the size and location of the scene(s).
- e. Select a progression of processing/collection methods so that initial techniques do not compromise subsequent processing/collection methods.
  - Concentrate on the most transient evidence (e.g., most susceptible to environmental conditions) and work to the least transient forms of physical evidence.
  - Move from least intrusive to most intrusive processing/collection methods.
- f. Continually assess environmental and other factors that may affect the evidence.
- g. Be aware of multiple scenes (e.g., victims, suspects, vehicles, locations). Processing one scene at a time to avoid cross-contaminating these various scenes
- h. Recognize other methods that are available to locate, technically document, and *collect* evidence (e.g., *alternate light source* enhancement, blood pattern documentation, projectile trajectory analysis).

**Summary:** Prioritization provides for the timely and methodical preservation and collection of evidence.

## 5. Crime Scene Search Methods

**Principle:** The thorough search of a crime scene helps ensure that all relevant evidence will be recognized, documented and collected.

**Policy:** The investigator(s) in charge shall consider different search strategies for crime scenes depending upon locale and the number of officials available to aid in searching.

**Procedure:** There are four types of search methodology that can be considered to search a crime scene:

- Lane or strip search
- Grid search
- Zone Search
- Spiral search

## *General Considerations*

- The size of the lane of the search should be approximately the arms' length of the searcher.
- As the search of an area is completed, some marking should be made to indicate that the area has been completed.
- A mechanism should exist for the circumstance when potential evidence is found (e.g. who is called over, what path they should take, whether the other searches should halt moving until this finding is resolved).

**Lane or Strip Searches** are accomplished by the searchers walking in parallel along defined lanes in the same direction.

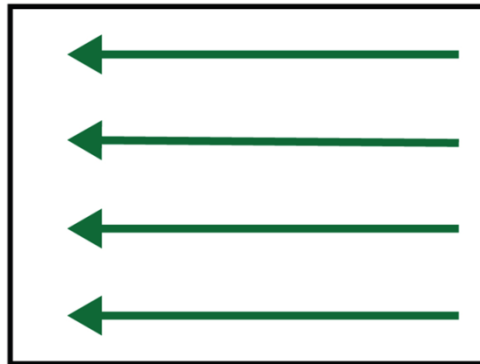

*Figure C-7. Lane or strip search*

A **Grid Search** is a lane search that is conducted by completing a lane search in one direction and then completing a lane search in a perpendicular direction. While it takes twice as long as a lane search, it provides a more thorough search of an area.

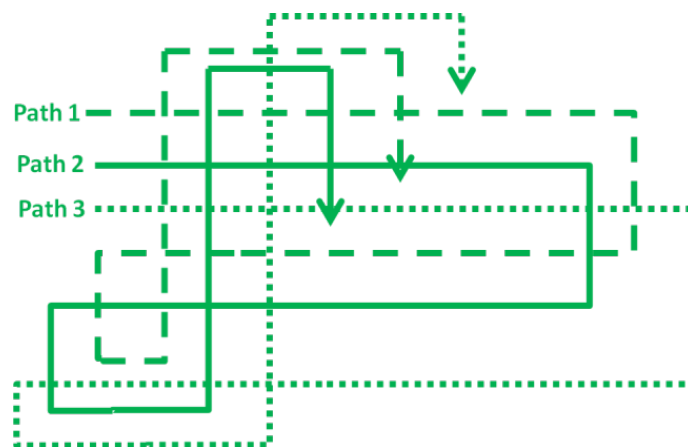

*Figure C-8. Grid search*

A **Zone Search** involves dividing the area to be searched into adjacent zones. The smaller the size of the zone, the more methodical the search can be. Zone searches may be done by multiple searchers per zone.

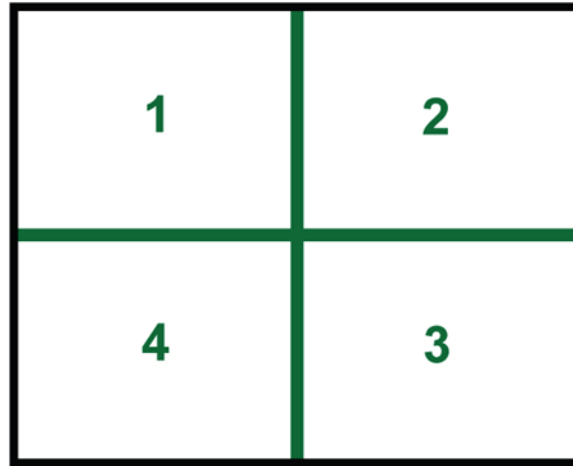

*Figure C-9. Zone search*

**Spiral search** involves a spiral into (inward) or out from (outward) a crime scene. A practical disadvantage with outward spiral searches is the evidence may be destroyed as the searchers move to the center of the crime scene area to begin their outward search.

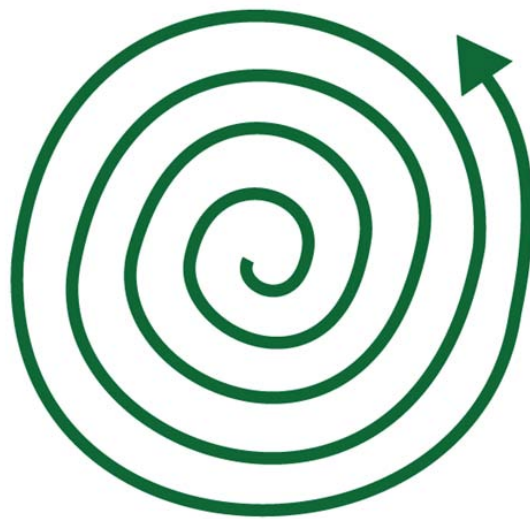

*Figure C-10. Spiral search (outward)*

## 6. Collect, Preserve, Inventory, Package, Transport, and Submit Evidence

**Principle:** The handling of physical evidence is one of the most important factors of the investigation.

**Policy:** The team member(s) shall ensure the effective collection, preservation, packaging, and transport of evidence.

**Procedure:** The team member(s) should:

- a. Maintain scene security throughout processing and until the scene is released.
- b. Document the collection of evidence by recording its location at the scene, date of collection, and who collected it.
- c. Collect each item identified as evidence.
- d. Establish chain of custody.
- e. Obtain standard/reference samples from the scene.
- f. Obtain control samples.
- g. Consider obtaining elimination samples.
- h. Immediately secure electronically recorded evidence (e.g., answering machine tapes, surveillance camera videotapes, computers) from the vicinity.
- i. Identify and secure evidence in containers (e.g., label, date, initial container) at the crime scene. Different types of evidence require different containers (e.g., porous, nonporous, crush-proof).
- j. Package items to avoid contamination and cross-contamination.
- k. Document the condition of firearms/weapons prior to rendering them safe for transportation and submission.
- l. Avoid excessive handling of evidence after it is collected.
- m. Maintain evidence at the scene in a manner designed to diminish degradation or loss.
- n. Transport and submit evidence items for secure storage.

## 7. Detailed Crime Scene Evidence Collection



**Principle:** The accurate and timely collection of evidence can lead to the reconstruction of a scene to determine if a crime has been committed, to the identification of suspect(s) and to the successful completion of the investigation.

**Policy:** First responders, investigators and specialized personnel who are properly trained, equipped and prepared shall collect any and all potential evidence.

**Procedure:** Appropriate personnel with the required knowledge and training should collect evidence in each of the following evidence categories as applicable.



## Ignitable Liquids

Accelerants and ignitable liquids recognition and collection are best performed by specialized personnel. For scene personnel, evidence may be observed through smell, sight and sound, and should be recorded in notes.

- a. NEVER attempt to collect any evidence until you have spoken with an accelerants and ignitable liquids investigator or specialist.
- b. Ensure the safety of people at or near the scene.
- c. Follow the instructions provided by the accelerants and ignitable liquids investigator or specialist with whom you speak.



## Bodily Fluids

Bodily fluids include blood, semen, urine and other physiological fluids.

### *Blood*

Possible substrates with blood stains:

- Clothing
- Entire portable object
- Part of a non-portable object
- Stain on a non-porous surface

### **Equipment needed for bodily fluid collection includes:**

Paper bags, boxes, and envelopes; cotton-tipped swabs; paper bindles or other sterile swab storage container; distilled water or one-time use sterile water; scalpel, utility knife, or scissors; clean paper; waterproof pen; evidence tape; protective gloves; face protection. Commercial products are also available for crime scene collection of stains

**Blood and other physiological fluids are fragile, and certain best practices must be maintained.**

- a. Do not package bloodstained evidence in plastic bags.
- b. If possible, collect the entire stained garment.
- c. Avoid altering the stain or transferring blood from one portion of the garment to another; do not fold or crumple the garment.
- d. Be careful not to lose or contaminate any remaining trace evidence on the garment.
- e. Avoid excessive heat when collecting, transporting or storing blood evidence.
- f. Avoid moisture, water or other liquids.
- g. Avoid exposing the bloody evidence to strong light, especially UV light.
- h. Avoid touching, taking off gloves, or coughing/sneezing over or near the evidence.
- i. Describe the stain as a “red stain” or “apparent bloodstain”. Do not label it as blood if the stain has not been forensically identified as such.
- j. Mark package with appropriate cautions about contents, such as “Store Frozen” or by affixing Biohazard stickers.

*Caution:* Leaving evidence exposed at a crime scene can lead to contamination. It may not be possible to dry an item at the scene without risking contamination.

***Bodily Fluids Packaging Guidelines***

**Documentation**

Ensure that the portion of the area or object with the stain has been documented as it was found. When photographing the object:

- Include a scale and an identification label.
- Take one or more location photographs that show the object where it was found.
- Show the relationship of the object to other evidence in the photograph.

**Marking Evidence**

**Evidence labeling:** Label a container such as a paper bag or envelope with your initials and identification number, the date and time, case number, evidence number, location and evidence description.

**Evidence number:** Each piece of evidence must have a unique number. This number should correspond to the placard next to the evidence.

**Evidence description:** The evidence description should include:

- Type of item (e.g., victim's shirt, glass, carpet fibers)
- Location of the stain
- Whether the stain is wet or dry
- Location of the item at the crime scene

### Drying Wet Material

- a. If the item is wet, place it on a clean piece of paper and allow it to dry before packaging, or transport it for drying at a laboratory facility or a properly outfitted evidence holding area.
- b. If you have access to a drying rack, dry the item in it. Place a clean piece of paper on the floor of the drying rack. Hang the item over the paper.
- c. If you do not have a drying rack:
  1. Lay a clean piece of paper on a clean, flat surface in a secure location where the item will not be disturbed and contamination will be minimized.
  2. Carefully place the item on the paper.
  3. Be sure to keep the stain intact in its original form and avoid transferring the stain from one area of the item to another.
  4. Allow the item to dry naturally. Never expose it to heat, such as from a blow dryer. Avoid exposing the sample to direct sunlight.
- d. Do not place two items in the same container for drying purposes. Clean the surfaces of the drying rack with a disinfectant such as 10% bleach solution after the item has been dried and removed.

### Packaging

- a. Collect and label the paper on which the object was dried.
- b. Place the paper into a labeled container, as needed.
- c. Carefully pick up and fold the paper on or over which the object was dried. Contain any trace evidence that may have fallen on the paper.
- d. Label the folded paper, indicating the evidence number of the item that was dried.

### Storing Blood

Ideally, bloodstained items should be stored in a temperature-controlled environment (between 60-75 degrees, with less than 60% humidity). If stored at ambient temperature:

- Place the container in a secure, dry storage area.
- Never expose the container to extreme heat, such as from a heater vent.
- Avoid exposing the container to direct sunlight.

### ***Specific Items Procedure: On Clothing***

- a. Label a container that will be used to collect the object. (See ***Bodily Fluids Packaging Guidelines***)
- b. Document the location of the garment with photography, measurement and sketching, where appropriate. If wet, dry according to guidelines.
- c. Fold garment and, whenever appropriate, wrap the garment in clean paper.
- d. When folding a garment or large object:
  1. Do not crumple or wad any portion of the garment.
  2. Fold the garment only enough so that it fits into the container.
  3. Do not crease the stained area.
  4. Make sure, if using paper, that the paper protects trace evidence and prevents transferring the stain to other areas of the garment.
- e. Only wrap an item if wrapping the object will not disturb the position of a stain or mark.
- f. An item should be wrapped in clean paper when the location or pattern of the stain or mark is significant (such as a handprint or spatter pattern).
- g. Position the paper to keep the stain or mark intact in its original form. Avoid transferring any of the stain or mark to another portion of the object.
- h. Mark package with appropriate Biohazard cautions regarding contents.
- i. Place the item into the labeled container, such as a paper bag. The container should be large enough to allow air to circulate around the object inside of it. If an object is too large to be packaged in a container, protect the stained area(s) with clean paper during transport.

- j. Close the container and seal the entire opening with evidence tape. Write your initials and identification number, and the date and time across the evidence tape seal.

***Specific Items Procedure: Entire Portable Object (e.g., a sheet)***

- a. Label a container that will be used to collect the object. (See ***Bodily Fluids Packaging Guidelines***.)
- b. Document the location of the object with photography, measurement and sketching, where appropriate. Dry, if wet, by placing it on or over a clean piece of paper and allowing it to dry before packaging; or dry in place.
- c. Whenever appropriate, wrap the object in clean paper. Only wrap an item when wrapping the object will not disturb the position of a stain or mark.
- d. Objects should be wrapped in clean paper when the:
  - Location or pattern of the stain or mark is significant (such as a handprint or spatter pattern).
  - Object is saturated and liquid will leak through the container if not wrapped.
- e. Position the paper to:
  - Keep the stain or mark intact in its original form.
  - Avoid transferring any of the stain or mark to another portion of the object.
- f. Place the object into the labeled container. If an object is too large to be packaged in a container, protect the stained area(s) with clean paper during transport.
- g. Close the container and seal the entire opening with evidence tape. Write your initials and identification number, and the date and time across the evidence tape seal.

***Specific Items Procedure: Part of a Non-portable Object (e.g., carpeting, car seat)***

- a. Label a container that will be used to collect the object. (See ***Bodily Fluids Packaging Guidelines***.)
- b. Document the location of the stain with photography, measurement and sketching, where appropriate.
- c. When multiple stains are found, take one or more photographs that show the relationship among those stains.
- d. It is important to collect the entire stained area if the shape of the stain is significant (such as a handprint).

- e. If possible, cut out the entire stained area using a clean scalpel, utility knife, or scissors, including a large portion of the non-stained area. If the stain has been absorbed into multiple layers (such as carpet and carpet pad), collect a cut-out from each layer.



*Figure C-11. Stained areas of carpeting are cut out for transport.*

- f. If the entire stained area is too large to collect, cut out a smaller section of the area.
- g. Opposite the stained side, mark the orientation of the cut-out; for example, mark the area that pointed north, when collected.
- h. If the cut-out is wet, place it on clean paper and allow it to dry before packaging.
- i. Whenever appropriate, wrap the object in clean paper if wrapping the object will not disturb the position of a stain or mark.
- j. Objects should be wrapped in clean paper when the:



- Location or pattern of the stain or mark is significant (such as a handprint or spatter pattern).
  - Object is saturated and liquid will leak through the container if not wrapped.
- k. Position the paper to keep the stain or mark intact in its original form. Avoid transferring any of the stain or mark to another portion of the object.
- l. **Control Sample:** Label a second container with your initials and identification number, the date and time, evidence number, location of the control in relation to the original sample, and description of the control sample.
- m. **Control sample number:** Each piece of evidence, including the control sample, must have a unique number. A letter or number may be appended to the original evidence number to denote the control sample; e.g., If the original evidence number was #32, the control sample could be #32A or #32.1.
- n. **Control sample description:** The description should include:
- Type of material
  - Location of material
  - Location of the control sample in relation to the stain
- o. **Collect a control sample:** Cut out a portion of unstained material.
1. First, locate an unstained area of the same material from which the original sample was taken. Select the least contaminated area possible (such as an unstained area of carpet).
  2. Cut out the control sample using a scalpel, utility knife, or scissors. (Use a clean blade; never use a blade that was used to cut another sample.) If multiple layers (such as carpet and carpet pad) of material were collected in the original sample, collect multiple layers for the control.
  3. On the side of the cut-out opposite the stained side (of the original non-control sample), mark the orientation of the cut-out to north when collected.
  4. If the cut-out is wet, place it on clean paper and allow it to dry before packaging. Package the control sample separately from the corresponding stained material.
  5. Place the cut-out in the container. Close the container and seal the entire opening with evidence tape. Write your



initials, identification number, and the date and time across the evidence tape seal.

***Specific Items Procedure: Stain on a Non-porous Surface (e.g., glass, a door, concrete surface)***

- a. Label a container that will be used to collect the item. (See ***Bodily Fluids Packaging Guidelines***.)
- b. Document the location of the stain with photography, measurement and sketching, where appropriate.
- c. When multiple stains are found, take one or more photographs that show the relationship among those stains.
- d. Pre-label with distinguishing markings any swabs that you will use.
- e. If the stain is dry, moisten the cotton tip of a swab using two or three drops of distilled water. If the stain has some residual moisture in it, touch the dry swab tip to the moist area of the stain.
- f. To avoid contamination, do not touch the cotton tip of the swab to any surface other than the sample area.
- g. Hold the bottle of distilled water, or a one-time use vial of sterile water, above the swab. Use a minimum amount of water to moisten the swab: drop two or three drops of water onto the swab:
  - Do not touch the tip of the water bottle to the swab.
  - Do not saturate the swab. (It should be moist, but not dripping wet.)
- h. Swab the stain with the cotton-tipped end of the swab. Touch the swab gently and firmly to the stain. Rotate the swab to ensure that the stain is collected on as much of the cotton tip as possible. Do not smear the stain when swabbing it.
- i. Dry the swab in a sterile container, swab dryer or drying box. If necessary, break off the end of the swab so it fits into the drying container.
- j. Place the swab into a bindle; ***fold the bindle*** so it seals around the swab. Close the bindle and place it into an envelope large enough to allow air to circulate around the object inside of it. If the swab is thoroughly dried, it can be placed directly into a pre-labeled envelope.
- k. If no bindle or ***swab drying box*** is available, use another sterile container that can hold the swab while it dries. Ensure that the swab is positioned so that air freely circulates around it.

- l. Close the envelope or other container and seal the entire opening with evidence tape. Write your initials and identification number, and the date and time across the evidence tape seal.
- m. **Control sample:** Label the second envelope with your initials and identification number, the date and time, evidence number, location of the control in relation to the original sample, and description of the control sample.
- n. **Control sample number:** Each piece of evidence, including the control sample, must have a unique number. A letter may be appended to the original evidence number to denote the control sample; e.g., If the original evidence number was #32, the control sample could be #32.A or #32.1.
- o. **Control sample description:** The description includes location of the control sample in relation to the original stain.
- p. **Collect a control sample:** Moisten the cotton tip of the second swab using two or three drops of distilled water. Swab an unstained area of the same surface from which the original swab was taken.
- q. Dry the swab and package in the same manner as the stained sample.

### *Additional Physiological Fluid Types*

#### Semen

- a. Label a container that will be used to collect the item. (See *Bodily Fluids Packaging Guidelines*.)
- b. Document the location of the stain with photography, measurement and sketching, where appropriate.
- c. **Locating semen stains:** Unlike blood stains, semen stains are not always obvious to the unaided eye at a crime scene. Semen stains are difficult to see under room and ambient lighting conditions. They may appear as a slightly yellow stain on light-colored fabrics or a whitish stain on dark-colored fabrics. Semen stains may also appear “crusty.”

Still, many stains will be missed by normal or unaided visual examination; therefore, it is best to collect any item that may have semen stains. Common items to collect are:

- Victim’s clothing, especially underwear of sexual assault victims
- Suspect’s clothing
- Bedding (e.g., blankets, sheets) where an alleged sexual assault took place

- Towels
  - Tissue paper, car seats
- d. **Detecting semen stains:** Items that are impractical to submit to the laboratory (e.g., vehicles, carpets) can be screened using special lighting techniques.

All visual lighting techniques are screening tests that can fail to detect semen stains; detection varies depending on the type of fabric or material on which the stain may be deposited. Visual tests will not discriminate between many possible physiological fluids or fluorescent contaminants.

*Forensic light source* is an alternate light source (ALS) that may cause semen stains to fluoresce when viewed through an appropriate color filter.

- Optimal wavelength is dependent on surface characteristics of item.
- Certain surfaces appear to quench the fluorescent reaction.

*Argon ion laser* causes a similar reaction as ALS.

*Long-wave ultraviolet (UV) lamp*

- As a precaution, analysts must wear plastic UV eye protection and cover any bare skin that will be exposed, such as hands and arms, during the UV examination or viewing.
- Semen stains may appear on a dark background.
- It should be noted that some clothing could fluoresce due to such materials as detergents and food stains.



*Figure C-12. A variety of substances, in addition to semen, may fluoresce under an ALS.*

- Avoid prolonged exposure of physiological fluids to the lamp.
- e. Collection of semen stains: Minimize disturbance, transference/swiping and contamination of the stain. Gloves should be worn during the collection and handling of the swab. Always collect a control sample.

Order of preference for collecting dry semen stains should be:

1. Collect entire item bearing the stain. Ensure that the stain will not flake off or become dislodged.
2. Cut the stain from carpet, upholstery or other item that cannot be collected.
3. Moisten a sterile swab with distilled water, swab the suspected semen stain, and air dry prior to packaging.

### Saliva

- a. Label a container that will be used to collect the item. (See *Bodily Fluids Packaging Guidelines*.)
- b. Document the location of the item with photography, measurement and sketching, where appropriate.
- c. Cigarette butts and used beverage cans or bottles are common types of saliva-containing evidence found at crime scenes.
- d. In sexual assault cases, consider swabbing the breast or other bodily areas to collect any potential saliva evidence if case circumstances dictate. Use a dry swab or moistened swab depending upon the circumstance of the stain.
- e. Use gloved hands or forceps to collect the item to prevent contamination. Do not lick the envelope flap or cough/sneeze on sample, or contamination of the sample may occur.

### ***Standard/reference sample for Bodily Fluids***

In order to compare DNA types from suspect(s) and victim(s) to evidence analysis results, a standard/reference sample must be collected. In cases involving semen as evidence, it is not necessary to obtain a semen reference standard. Saliva or buccal swab standards are recommended.

*Note:* Adhere to legal standards for search and seizure, if any, for your jurisdiction.

### **DNA reference material:**

Cellular material obtained by buccal swab (see *Male Suspect Evidence Collection*, Including Sexual Assault below) is sufficient for DNA analysis.

- The preferred method is to collect buccal or saliva swabs with several clean swabs.
- Finger-pricking the suspect and placing the blood drops on filter paper, or specialty paper designed for this purpose, is acceptable.
- This reference material should be handled and processed as evidence.



## Male Suspect Evidence Collection, Including Sexual Assault

### *Equipment Needed*

Paper bags, boxes, and envelopes; cotton-tipped swabs; paper bindles or other sterile swab storage container; distilled water; toothpicks; clean butcher paper; comb; waterproof pen; evidence tape; protective gloves; face protection. Commercial products are also available for suspect evidence collection.

- Do not package bloodstained or other biological evidence in plastic bags.
- Avoid altering the stain or transferring blood from one portion of the garment to another by folding or crumpling the garment.
- Be careful not to lose or contaminate any remaining trace evidence on the garment.
- Avoid excessive heat when collecting, transporting or storing blood and other biological evidence.
- Avoid unnecessary moisture, water or other liquids.
- Avoid exposing the bloody evidence to strong light, especially UV light.
- Avoid touching, coughing/sneezing over or near the evidence.

**Do not collect any samples without a court order, the suspect's consent or an exigent circumstance.**

### *Documentation*

- Suspects should be photographed in the clothing that they are wearing, in both overall and midrange photographs. A separate photograph of the face as well as the hands should be taken. Any scar, marks, tattoos and injuries, or lack thereof, should be photographed close-up.
- When photographing the subject, include a scale and an identification label.

### **Marking Evidence**

**Evidence labeling:** Label a container such as a paper bag or envelope with your initials and identification number, the date and time, case number, evidence number, location and evidence description.

**Evidence number:** Each piece of evidence must have a unique number. This number should correspond to the placard next to the evidence.

**Evidence description:** The evidence description should include:

- type of item (e.g., shirt, pants, shoes)
- from whom it was obtained
- color of clothing or other identifying marks on the clothing

Place suspect in a controlled area away from the victim's clothing and crime scene. Avoid having the collector of the victim's clothing collect the suspect's clothing so that cross-contamination is minimized.

**Trace evidence:** Unfold both sheets of paper; lay one on top of the other. Examine suspect for any extraneous hairs, fibers, plant material, soil, glass, paint, etc., found on the suspect. Place into bindle. Fold bindle to contain trace evidence; return bindle to envelope; seal envelope and complete label. Note location(s) of recovery.

Have suspect disrobe on the top sheet of paper. Place each garment in separate paper bags. Make sure any blood or semen stains are dry before packaging.

Refold top sheet of paper to contain any collected debris.

**Pubic hair combing:** Open bindle and place under pubic area. Using comb provided, comb pubic region for foreign material; fold paper to contain any debris collected and comb. Place in envelope, seal envelope and label.

**Pubic hair standard:** Pull (using fingers, or witness suspect pulling) 25 pubic hairs from various areas of the pubic region. Place hairs in paper bindle, fold bindle to contain hairs, place bindle in envelope. Seal envelope and label. Pubic hair standards are not always required. Check with your forensic service laboratory for their preference.

**Penile and digit swabs:** Use two cotton-tipped swabs held together and dampened with distilled water to swab the exterior of the penis and scrotum. Air-dry swabs or use a drying box, place dry swabs in envelope, seal and label. For digit swabs (if digital penetration indicated): Use 2 cotton-tipped swabs held together and dampened with distilled water to swab the fingers of each hand separately, to



remove possible vaginal fluid, etc., deposited by the victim. Air-dry swabs, place swabs in envelope, seal and label.

**Foreign stains on body:** Use two cotton-tipped swabs held together and dampened with distilled water to remove possible semen, vaginal fluid, saliva, urine, etc., deposited on suspect by victim.

**Bite marks:** Photograph as above, swab inside and outside the bite mark with a moistened swab, concentrating any material on the tip. Air-dry swabs or use a drying box, place in envelope, seal and label. Collect and package evidence from each area separately. Note location of recovery.

**Fingernail swabbings/clippings:** Swab under nails of each hand or clip the fingernails; place resulting residue and swab/clipping in a bindle. Fold bindle to contain debris; return bindle to envelope. Seal and label.

**Buccal swabs:** (Suspect should have rinsed mouth and had nothing in mouth for 15 minutes prior to collection of this sample.) Holding multiple swabs together, swab the inside of the cheeks. Air-dry swabs or place in a drying box, place in envelope, seal and label.

**Head hair standard:** Pull (using fingers, or witness suspect pulling) 25 head hairs from various areas of the head. Place hairs in paper bindle. Fold bindle to contain hairs. Place bindle in envelope, seal and label. Note: Head hair standards are not always required. Check with your forensic service laboratory for their preference.

**Blood standards:** See *Standard/reference sample for Bodily Fluids*

Package remaining sheet of paper suspect is standing on. Package separately. Close the container and seal the entire opening with evidence tape. Write your initials and identification number, and the date and time across the evidence tape seal.



## Bombs and Explosives

Bombs and explosives recognition and collection are best performed by specialized personnel. For scene personnel, evidence may be observed through smell, sight and sound; these factors should be recorded in notes.

- NEVER attempt to collect any evidence until you have spoken with a bombs and explosives investigator or specialist.
- Follow the instructions provided by the bombs and explosives investigator or specialist with whom you speak.



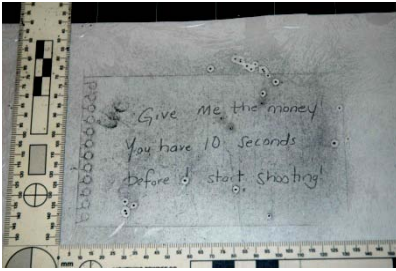

## Documents

For crime scene investigations containing voluminous documents, a Forensic Document Examiner (FDE) can provide valuable on-site support. The FDE can be effective in screening large numbers of questioned documents to assist in selecting representative samples that are more likely to provide useful information for a specific investigation. Similarly, the FDE can effectively screen larger numbers of existing known writing samples, e.g., forms within records available in personnel offices. The expertise of the FDE for these screening tasks can save many hours of investigator work time, limit the amount of unnecessary evidence taken for evaluation, and consequently reduce the time required for FDE examinations of the more relevant documents submitted.

### *Equipment Needed*

Paper envelopes<sup>1</sup> and boxes; pie boxes lined with sheet cotton<sup>2</sup>; paper towels; rolls or large sheets of window screen fabric; manila or other similar folders; clean sheets of paper; waterproof pen; evidence tape; protective gloves; face protection.

- Handle documents in a manner that prevents changes or alterations of the evidence. Never fold, unfold, staple, attempt to reassemble torn paper fragments, or allow shifting of torn or shredded paper fragments collected from waste containers, etc. Collect all questioned documents found at the scene. Check pockets for paper and paper fragments in clothing worn by suspects, victims, and other persons of interest at the scene; these fragments may be useful in associating the person with other document evidence.
- Collect all tablets, notepads, spiral-bound notebooks, etc., containing visible writing or not, as these may contain pages with decipherable indentations and/or paper fragments to associate them with questioned documents<sup>3</sup>. Collect handwriting samples: letters, diaries, and other existing written documents at

---

<sup>1</sup> Toner on documents produced from photocopiers or laser printers, correctible typewriting, stamps, glossy photograph surfaces, and other document components can adhere to plastic document protectors, resulting in damage when the items are removed from the protectors. They should not be used.

<sup>2</sup> Pizza and regular pie-shaped boxes containing sheet cotton stapled to both inner surfaces will immobilize documents placed within for safekeeping. This is particularly critical for charred documents and fragments.

<sup>3</sup> Indentations can be present from anonymous letters (some may be yet to surface) in an investigation. Paper fragments should be immobilized to avoid shifting and mixing that can delay reassembly of torn and shredded documents.

the scene (*standards*); also collect requested writing samples (*exemplars*) from victims, witnesses, and suspects who may not be available later to render samples of their handwriting.

- Collect computers, printers, typewriters, adding machines, check protectors, rubber stamps, embossers, etc., for comparison purposes, when these devices may be related to questioned documents in an investigation. Check any service documentation for these devices that may also be useful in associating devices with questioned documents.
- Collect paper, printer cartridges (ink, toner, and imaging drums), pens, markers, and other supplies that may be related to content of questioned documents.
- Never write on packaging containing a collected document once the document is inserted.
- Avoid altering a stain or mark in any way, other than as necessary for evidence collection (e.g., moistening a dried stain for swabbing).
- Always change gloves and use sterile tools when collecting a new sample.
- Do not cough, sneeze, or talk over any sample being collected or dried, to prevent contaminating the documents with additional DNA.

### ***Documentation***

Ensure that the item has been documented as it was found. When photographing the item:

- Include a scale and an identification label.
- When possible, shoot accurately scaled photography.
- Take one or more location photographs that show the item where it was found.
- Show the relationship of the item to other evidence in the photograph.

### ***Marking Evidence***

When acceptable, mark evidence containers instead of evidence. Mark documents for identification as inconspicuously and unobtrusively as possible. For instance, make small, limited markings in an area not intersecting any of the document printing or writing (e.g., very small initials and an abbreviated time/date entry along a bottom corner on the back of a document). Use a pencil for markings if documents might be examined later for latent prints.

**Evidence container labeling:** Label a container for the object as specified by your agency (e.g., your initials and identification number, the date and time, evidence number, location, and evidence description). When selecting a container:

- For paper that is charred or burned, use a rigid, flat box lined with sheet cotton or similar material.
- Use an envelope when collecting checks, receipts, letters, reports, or other similar documents. Always use envelopes that are larger than documents collected.

**Evidence number:** Each piece of evidence must have a unique number for identification. This number should correspond to the placard next to the evidence when photographing the items at a scene.

**Evidence description:** The evidence description should include:

- Sufficient detail to distinguish each item from similar items collected as evidence.
- Condition of the document.
- Orientation of the document to prominent nearby landmark.

Label the container just before inserting evidence into them. Seal containers as soon as appropriate to avoid cross-contamination, unnecessary movement of fragments, etc.

- Handle documents with gloves to avoid adding fingerprints that may obscure latent prints of evidentiary value.
- Use thicker paper, e.g., pieces of manila folders, to scoop up documents and insert them into paper envelopes or paper box evidence containers, etc.
- When necessary, pick up documents by touching the smallest area possible, such as one corner.
- Avoid bending, folding, unfolding, stapling, or otherwise altering document evidence.

### ***Drying Wet Documents***

To scoop up wet single-page documents, use cardboard sheets, e.g., pieces of manila folders. Wet documents can be dried by placing them on a clean piece of paper towel or a sheet of window screen, and then placed in a secure location for drying. Sheets of clean paper towels, etc., should be spread beneath the area used to handle moist documents in order to collect any trace evidence that falls from the

documents during handling. The items used to catch trace items may also need to be collected and handled as evidence.

- DO NOT attempt to unfold wet documents, as this should ONLY be done by laboratory forensic document examiners.
- Documents in a container of water or other liquid may need to be kept in the liquid for transportation to the laboratory and processing by forensic document examiners.
- Depending on the nature of the investigation, it may be important to avoid potential contamination that results from handling two documents in the same area at the same time.

### Packaging

- a. Place dried documents between clean sheets of paper, such as paper towels or cardboard sheets, to provide a protective covering before placing them into labeled evidence containers. Label evidence containers before placing objects into them to avoid degrading existing evidence. Handle documents carefully to avoid bending, folding, or otherwise degrading them. Handle documents appropriately to protect any latent prints that may exist.
- b. Close the container and seal the entire opening with evidence tape. Write your initials and identification number and the date and time, as required, across the evidence tape seal.
- c. Carefully pick up and fold the paper used as a catch-surface beneath drying documents. Retain any trace evidence that may have fallen onto this catch-surface paper from the evidence, by folding it inward from the corners. Then place the catch-surface paper in a labeled evidence container, as needed.
- d. Label the folded paper, indicating the evidence number of the item that was dried; e.g., “This paper was used below evidence #36 while it was drying.”
- e. Repackage the object using the original packaging and container if possible. Save all original packaging with evidence if it is not used for repackaging.
- f. If the original container cannot be reused:
  - Label the container indicating the evidence number of the item; e.g., “Original packaging for evidence #36.”
  - Put the labeled, original packaging into a new container with the evidence it was used to collect.

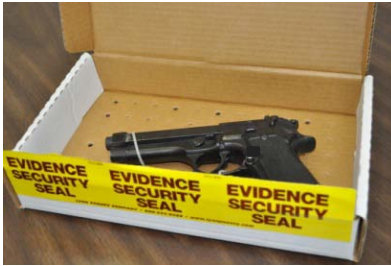

## Firearms

### *Packaging Guidelines*

#### Equipment Needed

Rigid, paper firearm and ammunition boxes, or other rigid, paper containers; clean paper; waterproof pen; evidence tape; evidence tags; and protective gloves.

- Avoid altering any stain on the firearm.
- Firearms should be unloaded and placed in a safe condition at the point of collection. If the collector is unsure of the proper procedure, assistance should be sought from a competent source such as a firearms instructor, departmental armorer, or an on-site firearm examiner. Always follow your department regulations.
- Ship firearms and ammunition according to your Department and the U.S. Department of Transportation's regulations.
- Do not cough, sneeze, or talk over any sample being collected or dried.

#### Documentation

- a. When photographing the firearm, include a scale and an identification label.



- b. Take one or more location photographs that depict the object where it was found in relationship to other evidence at the scene.
- c. Turn over the firearm, and photograph the other side if stains, serial number, or safety position is apparent on that side.
- d. If no serial number is present, mark the firearm with identifying data, such as your initials and the time and date on at least one component that cannot be removed. Also, place identifying data

- on removable component(s), such as cylinder, grips or ammunition magazine.
- e. When there is no serial number on the firearm due to the firearm's age, or the removal or defacement of the number, mark the firearm on non-removable parts, such as the barrel and the frame.
  - f. Photograph the firearm to capture any existing stains (such as blowback), the serial number, and the safety position.
  - g. Place the mark in a location that will not interfere with existing markings.

### Marking Evidence

**Evidence labeling:** Label the firearm box or a container for the object with your identifying data, such as initials and identification number, the date and time, evidence number, location, and evidence description.

**Evidence number:** Each piece of evidence must have a unique number or identifying data. This number should correspond to the placard next to the evidence.

**Evidence description:** The evidence description should include:

- Type of firearm
- Location of any stains on the firearm
- Whether the stains are wet or dry
- Location of the firearm

Label the container just before collecting an object, and seal the container immediately after collection. These actions help to protect the chain of custody.

When handling the firearm, do not touch areas of the firearm where latent fingerprints are likely to be found (such as on smooth surfaces). Handle the firearm by touching only the areas that are checkered or knurled.

### *Specific Items Procedure: Revolvers*

A revolver is defined as a repeating firearm that has a cylinder containing multiple chambers and at least one barrel for firing.

- a. Mark the cylinder with your initials and the time and date. Put the mark in a location that will not interfere with existing markings.
- b. Mark the cylinder position.
- c. Document the condition of the firearm. Information needed includes:



- Number of rounds in the chamber
  - Type and location of any stains
  - Serial number, make, model, and caliber
- d. Protect the barrel, chamber, or other operating surfaces from contact with other objects.
  - e. Handle the firearm by touching only those areas that are unlikely to contain latent fingerprints, such as areas that are checkered or knurled.

*Note:* Check agency evidence submission policy. For firearms that will be analyzed by a trained firearms examiner, a particular agency may require or prefer alternative procedures for submission of evidence to their laboratory.

- f. Determine which way the cylinder turns. Cylinder turn can be either clockwise or counterclockwise, from the perspective of the shooter.
- g. Create a cylinder diagram like the one below:

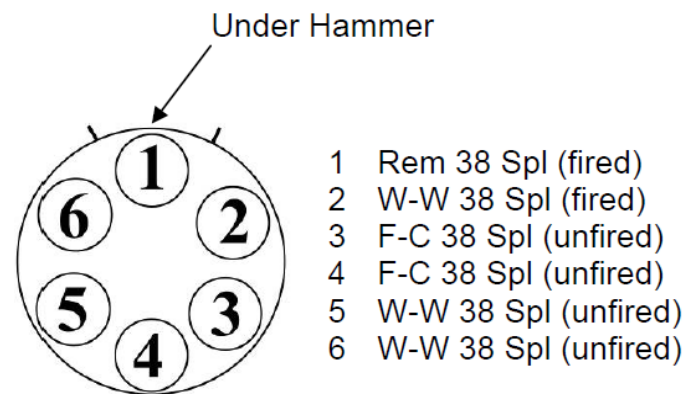

*Figure C-13. Cylinder diagram with assigned numbers for each chamber*

On the diagram, assign a number to each chamber in the cylinder. The chamber below the hammer/firing pin is number one. From number 1, continue numbering chambers as you move around it in the direction that the chamber turns. The diagram should show the state of each chamber – whether it contains a live or spent cartridge case, or is empty.

- h. Document in your notes the type of projectiles/bullets contained in each chamber of the cylinder that you observe. It is important to note the type of projectile/bullet used because more than one type could be in use in the firearm at the same



time; e.g., “Chamber one (1) contained .357 caliber ‘Acme’ full metal jacket.”

**Firearms should be unloaded and placed in a safe condition at the point of collection. If the collector is unsure of the proper procedure, assistance should be sought from a competent source such as a firearms instructor, departmental armorer, or an on-site firearm examiner.**

- i. Remove the cartridge or case from the chamber carefully to avoid disturbing any potential trace evidence or latent prints on it. Mark each cartridge or case with the related chamber number.
- j. When labeling the cartridge or case, make all marks in or near the mouth of the casing. Do not label a cartridge or case near the rim, head, or primer.
- k. Mark each cartridge or case with the number of the chamber in which they were contained. The cartridge or case directly below the firing pin is in position number one. Start with number one and move in the direction of the cylinder rotation. Label the container into which you will place the ammunition with the same chamber number as you wrote on the cartridge or case.

**If necessary, wrap each object carefully so as to protect any potential trace evidence.**

- l. Mark each chamber once you have marked the ammunition. On each side of the strap, mark the chamber with the number it was assigned when numbering cartridges and cases.
- m. Place the firearm, with available filled ammunition container(s), in the rigid box or container that you prepared for the firearm.
- n. If you are collecting multiple firearms, be sure to package each firearm and associated ammunition separately from other firearms.
- o. When the firearm is too large to fit into a container, securely attach an evidence tag to it. The evidence tag should include the following firearm information:
  - Caliber
  - Make
  - Model
  - Serial number
- p. Place the diagram into the labeled container with the firearm and filled ammunition containers. Make a copy of the diagram for your notes before placing the original copy into the box.

- q. Close the container and seal the entire opening with evidence tape. Write your initials and identification number and the date and time across the evidence tape seal.
- r. Consider the possible presence of bodily fluids, latent prints and trace evidence when handling the firearm or submitting it for processing.



### ***Specific Items Procedure: Other Firearms (e.g., Semi-Automatics, Automatics, Rifles)***

Refer to *firearms packaging guidelines*

- a. Document the identity of the firearm or the listed firearm's markings.
- b. If no serial number exists, mark the firearm with your initials and the time and date on at least one part that cannot be removed.
- c. When the firearm has a bolt, mark the bolt with your initials and the time and date.
- d. Information needed includes:
  - The safety position – on or off
  - Existence of ammunition in the chamber
  - Type and location of any stains
  - Serial number, make, model, and caliber or gauge
- e. Protect the barrel, slide, chamber, and other operating surfaces from contact with other objects.
- f. Handle the firearm by touching only those areas that are unlikely to contain latent fingerprints, such as areas that are checkered or knurled.

**Firearms should be unloaded and placed in a safe condition at the point of collection. If the collector is unsure of the proper procedure, assistance should be sought from a competent source such as a firearms instructor, departmental armorer, or an on-site firearm examiner.**

- a. If removing ammunition, mark each cartridge, case, shell, or magazine as it is removed from the firearm.
- b. Some departmental policies allow labels to be placed directly on a cartridge or case. When labeling the ammunition, make all marks near the mouth of the casing. Do not label ammunition near the rim, head, or primer.



Label cartridge casing  
in this area

- c. Mark each cartridge or case with the number of the chamber or position in the magazine in which they were contained, starting with number one, or use another schema that is consistent within your department for the way that the ammunition is stored in the firearm.
- d. Document, in your notes, the type of projectile/bullet that you observe in the chamber.
- e. It is important to note the type of projectile/bullet used; e.g., “Chamber contained .357 caliber ‘Acme’ full metal jacket.”
- f. Mark each magazine to note where cartridges, cases, or shells are found in it.
- g. On each side of the magazine, mark the position in which each numbered cartridge or shell is found.
- h. The mark should include the number assigned to the related cartridge, case, or shell. The number reflects the position in the magazine in which cartridge, case, or shell is found.
- i. Label a container into which you will place the ammunition with the same number as you wrote on the cartridge, case, shell, or magazine. The label on the box or container should include the number of the position in the magazine in which cartridge or case was found.
- j. If necessary, wrap each object carefully so as to protect any trace evidence on it.
- k. When the firearm does not fit into a container, attach an evidence tag that describes the caliber, make, model, and serial number.
- l. The trigger guard is frequently the attachment point for the evidence tag.
- m. The evidence tag should include the following information:
  - Caliber
  - Make
  - Model
  - Serial number

- n. Place the firearm and ammunition container(s) in the container that you prepared for the firearm.
- o. Close the container and seal the entire opening with evidence tape. Write your initials and identification number and the date and time across the evidence tape seal.
- p. Consider the possible presence of bodily fluids, latent prints and other trace evidence when handling the firearm or submitting it for processing.



## Ammunition

### *Specific Items Procedure: Embedded Ammunition*

#### Equipment Needed

Hand tools (hammer, chisel/screwdriver, metal and plastic forceps, hand saw, etc.); flashlight; paper bags, boxes, or envelopes; clean paper; waterproof pen; evidence tape; personal protective equipment.

- Gunshot residue and fingerprints are extremely fragile. Collect gunshot residue and fingerprints as soon as possible.
- When possible, collect the entire object in which the ammunition is embedded.
- Always wear protective gear when handling objects that could cut or otherwise cause injury to you.
- Do not cough, sneeze, or talk over any sample being collected or dried.

#### Documentation

When photographing the object:

- Include a scale and an identification label.
  - Take one or more location photographs that show the object where it was found.
  - Show the relationship of the object to other evidence in the photograph.
  - Use rods or strings to show ammunition entry and exit points
- a. In your notes, document characteristics of the object in which the ammunition is embedded. Information needed includes:
    - Type of object
    - Condition of object
    - Location of object

- Color of object
  - Location of ammunition in the object
  - Type of ammunition, when possible
  - Apparent entry angle
- b. Collect the object containing the embedded ammunition, when possible.
- c. If you were unable to collect the entire object, collect the embedded ammunition:
1. Use available tools (hammer, chisel/screwdriver, forceps, hand saw, etc.) to carefully loosen and remove the ammunition.
  2. Handle the ammunition carefully to avoid destroying marks on it. Pad the tips of the forceps, for example, to protect the extracted item from forceps marks.
  3. When fragments and other items related to the embedded ammunition are found in the object or fall from the object, collect them also.
- d. During collection, handle the object very carefully to avoid damaging evidence, or dislodging the embedded ammunition or any related residue.

### Marking Evidence

**Evidence labeling:** Label a container for the object with your initials and identification number, the date and time, evidence number, location and evidence description.

**Evidence number:** Each piece of evidence must have a unique number. This number should correspond to the placard next to the evidence.

**Evidence description:** The evidence description includes:

- Type of object
- Color of object
- Type of ammunition, when possible
- Location of the ammunition in the object, including orientation to key object feature(s); e.g., “Bullet of unknown type in piece of unstained wood beam in garage next to washing machine.”

Label the container just before collecting an object, and seal the container immediately after collection.

### Packaging

Place the object in the labeled container. Seal the opening of the container with evidence tape. Write your initials and identification number, and the time and date across the evidence tape seal.

#### ***Specific Items Procedure: Fired Cases or Wads***

### Equipment Needed

Hand tools (hammer, chisel/screwdriver, forceps, hand saw, etc.); flashlight; paper bags, boxes, envelopes, and bindles; clean paper; waterproof pen; evidence tape; personal protective equipment.

- Gunshot residue and fingerprints are extremely fragile. Collect gunshot residue and fingerprints as soon as possible.
- Use a “***druggist fold***” to create ***bindles*** that will be used to hold cases and wads.
- Always use clean gloves when handling evidence.
- Do not cough, sneeze, or talk over any sample being collected or dried.

### Documentation

When photographing the object:

- Include a scale and an identification label.
- Take one or more location photographs that show the object where it was found.
- Show the relationship of the object to other evidence in the photograph

### Marking Evidence

**Evidence labeling:** Label a container for the object with identifying data, such as your initials and identification number, the date and time, evidence number, location, and evidence description.

**Evidence number:** Each piece of evidence must have a unique number. This number should correspond to the placard next to the evidence.

**Evidence description:** The evidence description includes:

- Type of case or wad
- Type of weapon used, when known
- Location where the case or wad was found; e.g., “.357 caliber spent case found lying on the garage floor, beneath the stool.”

- Label the container just before collecting an object, and seal the container immediately after collection.
- Pick up the case or wad carefully to avoid damaging or dislodging fingerprints or other evidence. Use tools available to carefully loosen and remove the case or wad when it is difficult to reach and to avoid damaging evidence.

### Packaging

- a. Place the case or wad into the labeled envelope.
- b. When multiple cases or wads are collected from the same area, place each case or wad in a separate container. Each container must be individually labeled.
- c. Individual, labeled containers with cases found in the same area can be packaged together for transport. Wads should not be packaged with other ammunition or related objects.
- d. Close the container and seal the entire opening with evidence tape. Write your initials and identification number, and the date and time across the evidence tape seal.

### ***Specific Items Procedure: Loose, Unspent Ammunition***

#### Equipment Needed

Hand tools; flashlight; paper bag, box, or envelope; waterproof pen; evidence tape; protective gloves; face protection.

- Gunshot residue and fingerprints are extremely fragile. Collect gunshot residue and fingerprints as soon as possible.
- Always use clean gloves when handling evidence.
- Do not cough, sneeze, or talk over any sample being collected or dried.

#### Documentation

Photograph the ammunition and the location where it was found.

When photographing the object:

- Include a scale and an identification label.
- Take one or more location photographs that show the object where it was found. Show the relationship of the object to other evidence in the photograph.

#### Marking Evidence

**Evidence labeling:** Label an envelope for the ammunition with your initials and identification number, the date and time, evidence number, location and evidence description.



**Evidence number:** Each piece of evidence must have a unique number. This number should correspond to the placard next to the evidence.

**Evidence description:** The evidence description includes:

- Type of ammunition
- Location of unspent ammunition
- Orientation of ammunition relative to firearm or other point of interest, when possible; e.g., “Acme full metal jacket case for a .357 caliber revolver found on garage floor.”

Label the envelope just before collecting an object, and seal the envelope immediately after collection.

Photograph the ammunition and the location where it was found.

When photographing the object:

- Include a scale and an identification label.
- Take one or more location photographs to depict the object where it was found in relationship to other evidence in the photograph.

Pick up the ammunition carefully to avoid dislodging fingerprints or other evidence. Place the ammunition into the labeled container.

Unless departmental regulations state otherwise, do not wrap the casing. Wrapping it could disturb evidence that has not already been collected.

### Packaging

- a. Close the container and seal the entire opening with evidence tape. Write your initials and identification number and the date and time across the evidence tape seal.
- b. Collect and package any additional ammunition or related items.
- c. When multiple pieces of ammunition or related objects are found in an area, place each object in a separate container. Each container must be individually labeled. Those individual containers can then be packaged together for transport.



### Tool Mark Evidence

A tool mark is any impression, scratch, gouge, cut, or abrasion made when a tool is brought into contact with an item, leaving an impression of the tool. In some cases, tool mark identification may link a person to the tool used in the commission of a crime.

### Equipment Needed for Casting

Casting kit (e.g., Duplicast©, Mikrosil©, silicone-type sealant); mixing pad; stirring stick; flashlight and other available light sources; paper envelopes and boxes; waterproof pen; measuring tape/ruler; identification labels; protective gloves; face protection.

- Photograph the impression before casting it.
- When making a cast, be prepared to act quickly and methodically. Time is often a critical factor in successfully making a cast.
- Always use clean gloves when handling evidence.

### Documentation

Photograph the impression. When photographing the object:

- Include a scale and an identification label.
- Take at least one photograph where the camera lens is perpendicular or “orthogonal” to the tool mark surface.
- Take one or more mid-range location photographs that depict the object where it was found.
- Show the relationship of the object to other evidence in the photograph.

### Evidence Marking

**Evidence labeling:** Label a container for the object with identifying data, such as your initials and identification number, the date and time, evidence number, location, and evidence description.

**Evidence number:** Each piece of evidence must have a unique number. This number should correspond to the placard next to the evidence.

**Evidence description:** The evidence description includes:

- Type of item being cast
- Location of the item being cast
- Orientation of the item being cast; e.g. to the north, to a feature of the object with the impression on it, or to a nearby object.

### Casting the Evidence

- a. Label the container just before collecting an object, and seal the container immediately after collection.
- b. Clean out loose material from the impression, when possible, without disturbing the impression. Never discard a cast,

regardless of condition when removed from the impression. Be sure to save and submit all casts to the laboratory.

### Packaging

- a. Close the container and seal the entire opening with evidence tape. Write your initials, identification number, and the date and time across the evidence tape seal.
- b. Make sure that the container is also labeled with a description of the item cast, appropriate identifying data, such as your initials and identification number, the date and time, location and, when possible, the evidence number.
- c. If the item with the tool mark is collected, it should be packaged separately from a suspect tool(s) to prevent any additional marks, impressions or other damage. **Never place the suspected tool(s) into the impression.**



### Trace Evidence

Trace Evidence deals with the collection of all forms of matter, natural or manufactured, usually very tiny materials, but may also be larger forms of matter. Examples are from a container (bag or metal cylinder), hair, pollen, stains (non-biological), volatile liquids, fibers, paint, glass and soil. Trace evidence can be easily destroyed, contaminated, or transferred, so take precautions when approaching the scene.

- Since trace evidence items are often difficult to see without the aid of magnification, the prudent course of action is to collect items of evidence that may contain trace evidence.
- Care should be used when collecting weapons, as improper handling and packaging can compromise the trace evidence.
- Careful photography, documentation, and sketching are critical for the optimal use and interpretation/reconstruction of trace evidence.
- Always package items to prevent damage or alteration of the evidence: use packaging that corresponds to the size and type of the item and evidence.
- Always collect sufficient amounts of the trace evidence when possible.
- Do not package evidence if it is wet or damp.
- Do not package exemplar, standard/reference, or control samples with evidence. Package separately.
- Use of a bright or alternative light source may help in locating trace evidence.

- Standard, reference, and control samples should be collected for laboratory comparison, examination, or elimination purposes. Collect enough for multiple analyses.
- Always wear powder-free gloves while collecting trace evidence to avoid contamination.
- Change gloves as often as needed to minimize contamination.

### ***Trace Evidence Documentation and Packaging Guidelines***

#### **Equipment Needed**

Paper/manila envelopes; paper bags; 4-inch and/or 6-inch glassine weigh paper (for paper bindles or self-made envelopes); 2.5- to 4-inch wide clear adhesive tape, clear acetate sheet protectors or clear secondary liners (non-silicone or silicone coated one-side); tweezers/forceps with different tips; one-quart and one-gallon metal friction lid cans with fitting lids (clean, empty paint cans); glass jars, bottles, and vials with Teflon®-lined screw cap lids or other appropriate air-tight inert lid; glass Pasteur pipettes with rubber bulb or all-in-one plastic transfer pipettes; transparent tape; cotton-tipped swabs; swab-drying boxes, or other sterile swab storage containers; distilled water; cutting tool (knife, scalpel, single-edge razor blade, drywall saw, carpet knife, or box cutter); waterproof pen; evidence tape; powder-free protective gloves; face protection.

- Do not package evidence stained with bodily fluids or other liquids in plastic bags.
- Avoid altering the trace evidence in any way, other than is necessary for evidence collection (e.g., scraping paint from a metal surface).
- When possible, when storing evidence, use a freezer/refrigerator that is dedicated to evidence storage to guard against potential biohazard contamination or explosion hazards.
- Do not cough, sneeze, talk, or scratch yourself over any sample being collected or to be collected.
- When using tweezers/forceps, use only sufficient pinching force to collect item to prevent altering or damaging the trace evidence.
- Keep adhesive tape to be used in lifting evidence in a plastic bag until just before use to prevent contamination of the edges/side of the tape roll. Put unused portion of tape roll back into the plastic bag when finished with tape lifting.
- Do not place trace evidence directly into manila envelopes (of any size), paper envelopes, or paper bags without placing the

evidence into a smaller, leak-proof container such as a glassine bindle, canister, Teflon-lined screw cap glass vial (or bottle/jar as size dictates), or other container.

- Keep clear acetate sheet protectors free from contamination by storing in an appropriate size manila envelope or plastic resealable bag.
- Careful photography, documentation, and sketching are critical for the optimal use and interpretation/reconstruction of the evidence.
- To reduce breakage and loss of evidence, secure glass containers (e.g., vials, bottles, jars) in cushioned metal friction lid cans with lids. Cushioning material may be balled-up paper towels.
- Using a swab to collect a trace evidence sample – whether liquid, powder, gel, or other form of matter, evidential or control – is a last resort.

### Documentation

Ensure that the portion of the object with the stain or other trace evidence has been photographed and documented in notes and sketches. When photographing the object:

- Include a scale and an identification label.
- Photograph with and without scale.
- Take one or more location photographs that show where the object was found in relation to other objects in the crime scene.
- Show the relationship of the object to other evidence in the photograph.

### Marking Evidence

**Evidence labeling:** Label a container for the evidence object with your initials and identification number, the date and time, evidence number, location, and evidence description.

**Evidence number:** Each piece of evidence must have a unique number. This number should correspond to the placard or identification label next to the evidence and the evidence log as appropriate.

**Evidence description:** The evidence description includes:

- Type of evidence (paint, plant stem, glass, etc.)
- Original location of the trace-evidence-containing object
- Location of the trace evidence on the object (as appropriate)

When describing non-DNA-related stains, use the word “apparent” or the phrase “of unknown origin” when the source of the stain is not scientifically identified; e.g., “Pillow containing a brown stain of unknown origin found on the lower bed sheet on the bed.”

Label the container just before collecting the object, and seal the container immediately after collection. These actions help to protect the integrity of the trace evidence and the chain of custody.

### Packaging Wet Evidence

- a. If the item is wet, determine if the liquid is significant or relevant to the case (for instance, acid splashed on a victim). You may not wish to dry the item if the liquid is relevant to the case.
- b. If the liquid is not relevant, place item on a clean piece of paper in a secure location used for evidence drying, such as a drying rack, until it is dry.
- c. If you have access to a drying rack, dry the item in it. Place a clean piece of paper below the evidence to be dried in the drying rack. Lay the item on or hang it above the paper.
- d. If you do not have a drying rack:
  - Lay a clean piece of paper on a clean flat surface (e.g., table top) in a secure location where the item will not be disturbed and contamination or loss of the trace evidence due to drafts created by people walking by will be minimized.
  - Carefully place the item on or hang it over the paper. If possible, gently fold the paper over the object to cover it from airborne particles (such as hair or fibers) that might land on it.
  - Allow the item to dry naturally. Never expose it to heat or significant drafts, such as from a blow dryer. Avoid exposing the sample to direct sunlight.
- e. Do not place two items in the same container for drying purposes.
- f. If the liquid is relevant to the case, determine if the liquid is:
  - related to a fire or explosion and in or on an object (e.g., ignitable liquid in carpet) – contact fire investigator or bomb technician or forensic fire debris or explosives analyst as appropriate
  - involved in injury or damage to another person or property and on an object



- if small sample – secure in appropriate size glass container with a Teflon-lined screw cap lid or other airtight, non-reactive lid.
  - if large sample – document location of wet area by photography, notes, and sketches, then cut or remove the wet area and treat as if small sample
  - soaking the object or there are drops of liquid on the surface (non-porous surface) – using gloved hands, attempt to squeeze liquid drops into glass container or use swab to collect drops and treat as small sample
  - forming a large drop or pool of liquid. Transfer liquid using glass Pasteur pipette or plastic transfer pipette into appropriate size glass vial.
- g. Consider appropriate hazardous labeling.

### Packaging Dry Evidence

- a. When object has dried, carefully pick up and fold the paper on or over the object that has dried. Contain any trace evidence that may have fallen on the paper.
- b. Label the folded paper, indicating the evidence number of the item that was dried; e.g., “This paper was used below evidence #36 while it was drying.”
- c. If possible, repackage the object using the original paper and container.
- d. If the original container cannot be reused:
  1. Save all original packaging as evidence if it is not used for repackaging.
  2. Put the labeled, original packaging into a new container with the evidence it was used to collect.
  3. Label the container indicating the evidence number of the item; e.g., “Original packaging for evidence #36.”
- e. When possible, place glass vials, bottles, and jars into a cushioned metal friction lid container to reduce breakage.
- f. To reduce breakage and loss of evidence, secure glass containers (e.g., vials, bottles, jars) in cushioned metal friction lid cans with lids. Cushioning material may be balled-up paper towels.
- g. Do not place trace evidence directly into manila envelopes (of any size), paper envelopes, or paper bags without placing the evidence into a smaller, leak-proof container such as a



glassine/paper bindle, canister, Teflon-lined screw cap glass vial (or bottle/jar as size dictates), or other container.

- h. Keep clear acetate sheet protectors free from contamination by storing in an appropriate size manila envelope or plastic resealable bag.
- i. Tape lifts should be placed onto clean, clear (not translucent) acetate sheet protectors. Then place the sheet protectors into appropriate size manila envelope.

### Collecting a Control or Comparison Sample

A **control sample** is one that the collector knows, that does not appear to have evidence present. It represents the matrix material on which the evidence rests, for instance a piece of wallboard or carpeting. A **comparison sample** may have evidence present without the collector's knowledge (e.g., fire debris), but represents the matrix material on which the evidence rests or is made of the same matrix material as the evidence (e.g., glass fragments collected from a broken window). It will be compared to the evidential sample. These will be referred to as "control" samples. Label a second container for the control sample with your initials and identification number, the date and time, evidence number, location of the control in relation to the original sample, and a description of the control sample. Clearly identify this sample as a control (or comparison) sample (e.g., write the words "Control Sample" or "Comparison Sample" in bold print on the container).

Control sample number: Each piece of evidence, including the control sample, must have a unique number. A letter or number may be appended to the original evidence number to denote the control sample (e.g., if the original evidence number was #32, the control sample could be #32A or #32.1.)

Control sample description: The description includes:

- Type of sample or matrix material (e.g., wallboard)
- Location of the material
- Location of the sample in relation to the evidence sample

Collect a control sample: Using the appropriate tool, cut out, collect, or remove a portion of the same matrix material on which the evidence sample rests or was part of the evidence sample (e.g., paint smear evidence on paint). Locate an area of the same material from which the original trace evidence sample was taken, but without evidence being present (e.g., undamaged area of paint).

Cut out, collect, or scrape the control or comparison sample using, as appropriate, a scalpel, utility knife, wallboard saw, carpet knife, single edge razor blade, or scissors. (Whenever possible, use a clean blade;

never use a blade that was used to cut an evidential or other control sample without changing or thoroughly cleaning.) If multiple layers (such as carpet and carpet pad or multi-layer paint) of material were observed or collected in the original sample, collect all of the multiple layers for the control or comparison sample.

A liquid sample should be collected using a glass or plastic transfer pipette and placed into a glass Teflon-lined screw-cap vial or bottle of the smallest permitted size for the sample. Using a swab to collect a liquid trace evidence sample (evidential or control) is a last resort. Put the swab into an appropriate size screw-cap vial or other air-tight container.

### ***Trace Evidence Collection Procedures***

#### ***Remove an Entire Portable Object***

#### ***Part of a Non-Portable Object***

#### ***Scrape from Non-Portable Object***

#### ***Lift with Tape or Adhesive***

#### ***Recovery with Tweezers***

#### ***Swab a Surface***

#### ***Soil or Rock Samples***

#### ***Gunshot Residue***

### ***Collection Procedure: Remove an Entire Portable Object***

Follow ***Trace Evidence Documentation and Packaging Guidelines***

1. Photograph and document the object with the apparent trace evidence.
2. Whenever appropriate, wrap the entire object in clean (butcher) paper or in a brown paper bag.
  - Only wrap an object when doing so will not disturb the position of a stain or other trace evidence (glass fragment, metal fragment, paint smear, etc.).
  - Objects should be wrapped in clean paper when the location or pattern of the stain or other trace evidence is significant (such as a spatter pattern) or the object is saturated and liquid will leak through the container if not wrapped.
3. Position the paper to keep the trace evidence intact in its original form. Avoid transferring any of the trace evidence to another portion of the object.

4. Place the wrapped object into the brown paper bag or other labeled container.
5. If an object is too large to be packaged in a container, protect the stain or trace evidence area(s) with clean paper during transport.
6. Close the container and seal the entire opening with evidence tape. Write your initials, the identification number, and the date and time across the evidence tape seal. Ensure that any small openings in the package are also sealed. Place initials over these seals.
7. If an object is too large to be packaged in a container, protect the relevant area(s) with clean paper during transport.
8. Repackage the object using the original packaging, if possible, and reseal.
9. Store the object in the sealed container.
10. Place the container in a secure, dry storage area.
11. Never expose the container to extreme heat, such as from a heater vent.
12. Avoid exposing the container to direct sunlight.



***Procedure: Cut from a Non-Portable Object***

Follow ***Trace Evidence Documentation and Packaging Guidelines***

- a. Label a container for the object to be collected with your initials and identification number, the date and time, evidence number, location, and evidence description.
- b. Photograph, sketch, and take notes on the object with the trace evidence or stain.
- c. Collect a larger area than where the trace evidence is observed, especially if the shape or pattern of the trace evidence or stain is significant (e.g., paint spray, broken glass pane, etc.).
- d. If possible, cut out the entire area using a scalpel, single-edge razor blade, utility knife, carpet knife, dry wall saw, scissors or other tool as needed to remove section. If the trace evidence has been absorbed into multiple layers (such as carpet and carpet pad), collect a cut-out from each layer.
- e. If the entire stained or evidence area is too large to collect as one piece, using the appropriate tool, cut out a smaller section of the area and label to re-assemble the sections later if needed.

- f. On the side of the cut-out opposite the side with a stain or trace evidence, mark the orientation of the cut-out to north when collected. Be careful not to dislodge trace evidence while marking.
- g. If the item is “wet”, determine if the liquid is water, a biological fluid, volatile, or hydrocarbon.
  1. If water or biological fluid, place it on or over a clean piece of paper and allow it to dry before packaging. See *Packaging Wet Evidence*.
  2. If the liquid is volatile, acidic, caustic, or a hydrocarbon, the liquid itself may be significant evidence and must be packaged in an airtight container to prevent evaporation. Contact a fire investigator, fire debris analyst, or bomb technician for instructions. (See *Trace Evidence Documentation and Packaging guidelines*.)
- h. Whenever appropriate, wrap the cut object in clean paper, glassine bindle, or place in appropriate size glass or plastic container or metal friction lid can.
- i. Close and seal the labeled container after having placed the object into it. Write your initials and identification number and the date and time across the evidence tape seal.
- j. If an object is too large to be packaged in a container, protect the area(s) with clean paper during transport.

**Control sample:** Label a second container for the control sample with your initials, identification number, the date and time, evidence number, location of the control in relation to the original sample, and a description of the control sample. Clearly identify this sample as a control or comparison sample (e.g., write the words “Control Sample” or “Comparison Sample” in bold print on the container).

**Control sample number:** Each piece of evidence, including the control sample, must have a unique number. A letter or number may be appended to the original evidence number to denote the comparison or control sample (e.g., if the original evidence number was #32, the control sample could be #32A or #32.1.)

**Control sample description:** The description includes:

- Type of sample or matrix material (e.g., wallboard)
- Location of the material
- Location of the control sample in relation to the evidence sample

**Collect a control sample:** Using the appropriate tool, cut out or remove a portion of the same matrix material on which the evidence

sample rested or was part of the evidence sample (e.g., locate an area of the same material from which the original trace evidence sample was taken but without evidence being present such as an undamaged area of paint).

- a. Cut out the control or comparison sample using, as appropriate, a scalpel, utility knife, wallboard saw, carpet knife, single-edge razor blade, or scissors. (Use a clean blade; never use a blade that was used to cut an evidential sample on a control sample without a thorough cleaning or replacement.) If multiple layers of material (such as carpet and carpet pad or multi-layer paint) were observed or collected in the evidential sample, collect all of the multiple layers present for the control or comparison sample.
- b. On the opposite side of the evidential side of the original non-control sample, mark the orientation of the cut-out to north when collected.
- c. Whenever appropriate, wrap the control sample in clean paper or other appropriate containment.
- d. Place the object into the labeled container. If an object is too large to be packaged in a container, protect the sample with clean paper during transport.
- e. Close the container and seal the entire opening with evidence tape. Write your initials and identification number and the date and time across the evidence tape seal.

**Treat the control sample with the same care as you treat the transfer evidence sample.**

### ***Collection Procedure: Scrape from Non-Portable Object***

Follow ***Trace Evidence Documentation and Packaging Guidelines***

#### **Equipment Needed**

Paper/manila envelopes; brown paper bags; 4-inch and/or 6-inch glassine weigh paper (for paper bindles or self-made envelopes); tweezers/forceps with different tips; cutting tool (knife, scalpel, single-edge razor blade, or box cutter); waterproof pen; evidence tape; powder-free protective gloves; face protection.

- Use scraping when the entire object may not be collectable (e.g., quarter panel of car, etc.)
- Often scraping is used to collect evidence on non-porous surfaces too large to collect, but may be used to collect evidence on porous surfaces (e.g., stain on car seat, furniture fabric, canvas, etc.)

- Paint transfer is commonly located on the object on the impacted surface.
- Collect the clothing and shoes of people who have been in the area of the painted surface at the time of and since the impact.
- Collect paint control-comparison samples, when the entire item cannot be removed, using the scrape method.
- Always use clean and/or fresh, disposable scraping tools. Change blades frequently when applicable.
- Always change gloves and use thoroughly cleaned tools when collecting each new sample (between every evidential or control sample.)
- The stain or marking should be dry for scraping.
- Do not use a commercially manufactured envelope of any kind as they have gaps that permit leakage. If a commercial envelope must be used, seal around all edges of the envelope with tape.
- Label a container for the object to be collected with your initials and identification number, the date and time, evidence number, location, and evidence description.
- Photograph, sketch, and take notes on the object with the trace evidence or stain.
- Collect as much of the evidence area as possible using a scalpel, single-edge razor blade, utility knife, or other tool as needed to remove section.
- On vertical surfaces, place or tape a *self-made envelope* or *glassine bindle* below the area to be scraped before scraping to capture all of the scraping.
- By scraping the sample, typically all shape or pattern of the trace evidence or stain is lost.

**Evidence labeling:** Label a container for the evidence-scraped object with your initials and identification number, the date and time, evidence number, location, and evidence description. Use a druggist fold to create a glassine paper bindle or self-made envelope.

**Evidence number:** Each piece of evidence must have a unique number. This number should correspond to the placard next to the evidence and the evidence log as appropriate.

**Evidence description:** The evidence description should include the:

- Type of scrape evidence (paint, apparent vomit, etc.)
- Original location of the object containing the trace evidence



- Location of the trace evidence on the object (as appropriate)
- a. Label an appropriate container just before collecting the scraping, and seal the container immediately after collection.
- b. Place a large sheet of clean paper beneath the area that you will scrape. The paper is used to contain any debris that breaks loose while you are scraping. Avoid standing on the paper while you scrape.
- c. Place or tape a self-made envelope or glassine bindle below the area to be scraped before scraping to capture all of the scraping possible. Do not use a commercially manufactured envelope of any kind as they have gaps that risk leakage.
- d. Scrape off as much of the material as possible and go as deep as possible to obtain all layers.  
*Note:* When scraping flakes, attempt to leave the flake as intact as possible as you remove it.
- e. When scraping paint, as when found on a car, scrape down deep to the base material, such as the metal of the car. Collect all layers of paint available (all evidence layers and all matrix layers on which evidence rests) in one scrape. This method applies to all trace evidence to be scraped.
- f. If ample evidence is present, attempt to collect a sample that is at least the size of a quarter when scraping material that is not a flake. Otherwise, scrape and collect all of the evidence present.
- g. Scrape the material directly into a paper bindle or self-made envelope. A bindle or self-made envelope is preferred for collection to be able to recover as much of the evidence from inside of it as possible.
- h. Close and seal the bindle or envelope to prevent leakage.
- i. Never use staples to seal a bindle containing trace evidence.
- j. Place a small section of tape at the point where the top is tucked into the bottom just sufficient to keep the bindle top tucked into the bottom. Do NOT over wrap the bindle or envelope with tape.
- k. Place the bindle or self-made envelope into an appropriate size labeled container.
- l. Take necessary precautions to avoid breaking or damaging larger flakes by affixing the bindle or envelope to a piece of cardboard or other rigid material. Secure the bindle or envelope to keep it



from moving with minimum amount of transparent tape (not evidence tape or packing/tape lifting tape).

- m. Fold the paper that was below the paint when scraped, and place it into a labeled container. Keep all evidence from the same scrape together using detailed labeling of the containers and evidence tape.
- n. Close the container and seal the entire opening with evidence tape. Write your initials and identification number and the date and time across the evidence tape seal.

**Control sample:** Label a container for the control or comparison sample with your initials, identification number, the date and time, evidence number, location of the control in relation to the evidence sample, and a description of the control sample. Clearly identify this sample as a control or comparison sample (e.g., write the words “Control Sample” or “Comparison Sample” in bold print on the container).

**Control sample number:** Each piece of evidence must have a unique number. This number should correspond to the placard next to the evidence and on the evidence log; e.g., “#36.A - Control sample for evidence #36.”

**Control sample description:** The description includes:

- Type of item scraped (e.g., paint, apparent brown stain on glass, etc.)
- Location of the object scraped
- Location of the scrape on the object

**Collect a control sample:** Collect a comparison or control sample by scraping an area close to or adjacent to the transfer scraping. (Use a clean, new blade; never use a blade that was used to scrape another sample.) Collect a control or comparison sample that is, at a minimum, the size of a quarter. Collect a sample that cuts through all layers of material down to the solid or base surface, as when collecting a paint sample from a car.

- a. Place or tape a self-made envelope or glassine bindle below the area to be scraped before scraping to capture all of the scraping possible. Do not use a commercially manufactured envelope of any kind as they have gaps that permit leakage.
- b. Scrape off as much of the material as possible and go as deep as possible to obtain all layers.
  - *Note:* When scraping flakes, attempt to leave the flake as intact as possible as you remove it.

- c. When scraping (e.g., paint, as when found on a car) scrape down deep to the base material, such as the metal of the car. Collect all layers available in one scrape if possible.
- d. Place the scraping directly into the bindle or self-made envelope.

**Never package comparison or control samples with transfer evidence samples.**

- e. Place the bindle or envelope into the labeled container.
- f. When the bindle or envelope contains larger flakes, place it onto a rigid material similar to the evidence sample then into a container and secure it to prevent the bindle or envelope from moving. Take necessary precautions to avoid damaging the flakes.
- g. Close the container and seal the entire opening with evidence tape. Write your initials and identification number and the date and time across the evidence tape seal.
- h. Store the object in the sealed container.

**Treat the control or comparison sample as you would treat the transfer evidence sample.**

***Collection Procedure: Lift with Tape or Adhesive***

Follow ***Trace Evidence Documentation and Packaging Guidelines***

**Additional Equipment Needed**

Clear tape (packing or box sealing tape with a width of 2.5 inches to 4 inches) on a roll (tape lift), sheet lift tape, clear acetate page protector or acetate sheets, clear secondary liners (non-silicone or silicone coated one-side), and clean butcher paper.

- A tape lift has the advantage over vacuuming by collecting evidence most recently deposited relative to the crime.
- Suitable types of tape to use are packing or box-sealing tape with a width of 2.5 inches to 4 inches.
- Do not use fingerprint lift tape, latent print tape strips or lifters unless as a last resort. While excellent for fingerprints, these often have insufficient adhesive for trace evidence.
- Do not use masking tape, clothing hair-removal tape, duct tape, or other non-transparent tapes.
- Do not use paper as a backing for tape adhesive. Use acetate page protectors or clear secondary liners.

- Hair is frequently located at a crime scene near a weapon, near the point of impact, and below a deceased person, on clothing worn during the crime.
- Fiber is frequently located at a crime scene on clothing, carpet, furniture, and bedding. Fiber is usually defined as carpet and clothing filaments.
- Broken glass is frequently found on clothing, shoes, head hair, skin, tools, and weapons.
- Paint is commonly located on the object that impacted the painted surface, the area below/around the painted surface that was impacted, and the clothing and shoes of people who have been in the area of the painted surface at the time of or since the impact.
- Do not freeze the lift.
- To collect paint samples when the entire item cannot be removed, use the tweezers collection method first, then the scrape method, then the tape lift method.
- Always use powder-free clean gloves when handling evidence.
- Do not cough, sneeze, scratch, or talk over any sample being collected or dried.
- Whenever possible, collect the entire item and submit it to the lab.
- Collect trace evidence (e.g., hair, fiber, paint, etc.) using tweezers when possible, then use tape lifts.

### Marking Evidence

**Evidence number:** Each piece of evidence must have a unique identification number. This number should correspond to the placard next to the evidence and the evidence log as appropriate.

**Evidence labeling:** Label the acetate page protector or secondary liner along an edge and a container for the sheet or liner with your initials, identification number, the date and time, evidence number, lift location (e.g., lower, bed sheet, left-front shirt). Label each tape lift with your initials, the date, and identification evidence number. As appropriate (e.g., when collecting a series), add additional specific location information to the tape end.

On the tape, a letter may be appended to the original evidence number to denote the lift. If the original evidence number was #36, for example, the number on the bundle could be #36A or #36.1. If several lifts are from the same evidence item (e.g., shirt) then the same sub-number (e.g., #36A) can be used for all lifts on the same

acetate page protector or unique numbers used for each separate lift, according to department preference.

**Evidence Description:** The evidence description should include the:

- Type of evidence
  - Location of the evidence
  - Description of surface from which lift is taken
  - Brief description of evidence, when appropriate, such as “blue-colored glass” or “apparent smokeless powder”
- On the envelope, avoid using adjectives, such as “long” or “blonde”, to describe hair; e.g., “Hair and other items lifted with tape from green area rug lying across the floor two feet east of the back door.”
- On the bindle, when it is used for debris, refer to the evidence with which the content of the bindle is associated; e.g., “Debris from evidence #36.”
- Label the container just before collecting a sample, and seal the container immediately after collection.

### Lifting Trace Evidence

(Tape on a roll or as used in sheets are considered “tape.” Acetate sheets, page protectors, and release liners will be “backing.”)

- a. Remove a little longer clear tape from the roll than will be needed to tape lift the intended surface. Fold approximately an inch of tape onto itself on the ends.
- b. Place the tape evenly on the surface to be tape lifted. Press repeatedly and firmly along the length of the tape. Peel the tape off of the surface carefully so as to keep evidence from falling off of it. If surface pattern is important, place adhesive side of tape on the backing. If pattern is not important, repeatedly place the tape onto new areas of the surface with potential evidence several times, but before the tape loses stickiness. Place the adhesive side of the tape onto backing.
  - If lift tape is being used, open the tape lift and remove the protective seal over the sticky part of the lift.
  - If clear tape is being used, remove a piece of tape.
- c. While holding the tape over clean paper, close the lift tape or place the piece of clear tape against the sheet of acetate.

- If lift tape is being used, carefully place the backing over the sticky surface.
  - If clear tape is being used, carefully place the tape on the acetate.
- d. Be sure not to let any evidence fall from the tape lift or clear tape.
  - e. If the tape lift or clear tape is not sticky enough to securely attach to the backing or acetate, use an additional piece of tape to secure it to the backing.
  - f. Label the tape with your initials, identification number, the date and time, evidence number, and location as appropriate. The backing should be labeled along a margin parallel to the direction of the tape with your initials, identification number, the date, evidence number, location and description

### Packaging

- a. Place the tape lift into the labeled envelope. The envelope and tape backing should have identical information on their labels.
- b. Save any debris that fell off of the tape onto the clean paper by folding the paper into a bindle and placing it into an envelope. Take care to fold the paper in such a manner as to contain all debris; using a “*druggist fold*” to make a bindle is recommended. The container should be labeled in the same manner to match the lift envelope’s label.
- c. If a control or comparison tape lift is made, package separately from the evidence tape lift.
- d. Close the container and seal the entire opening with evidence tape. Write your initials, identification number, and the date across the evidence tape seal.
- e. Store lifts in a secure, dry storage area until they are submitted.



### ***Collection Procedure: Recovery with Tweezers***

Follow ***Trace Evidence Documentation and Packaging Guidelines***

### Additional Equipment Needed

Fresh disposable or clean, smooth-tipped tweezers. Paper/manila envelopes; 4-inch and/or 6-inch glassine weigh paper (for paper bindles or self-made envelopes); tweezers/forceps with different tips; waterproof pen; evidence tape; powder-free protective gloves; face protection

- Hair is frequently located at a crime scene near a weapon, near the point of impact, and below a deceased person, on clothing worn during the crime.
- Fiber is frequently located at a crime scene on clothing, carpet, furniture, and bedding. Fiber is usually defined as carpet and clothing filaments.
- Broken glass is frequently found on clothing, shoes, skin, tools, and weapons.
- Paint is commonly located on the object that impacted the painted surface, the area below/around the painted surface, and the clothing and shoes of people who have been in the area of the painted surface at the time of or since the impact.
- Always use clean, powder-free gloves when handling evidence.
- Do not cough, sneeze, talk, or scratch over any sample being collected or dried.
- Broken glass is frequently found on clothing, shoes, head hair, skin, tools, and weapons.
- Paint is commonly located on the object that impacted the painted surface, the area below/around the painted surface that was impacted, and the clothing and shoes of people who have been in the area of the painted surface at the time of or since the impact.

### Marking Evidence

**Evidence Labeling:** Label a container for the bundle or envelope with your initials, identification number, the date and time, evidence number, location, and evidence description. Label the *bundle* or envelope with your initials, identification number, evidence number, the date, and evidence description.

**Evidence Number:** Each piece of evidence must have a unique number. This number should correspond to the placard next to the evidence and the evidence log as appropriate.

**Evidence Description:** The evidence description should include the:

- Type of evidence
- Location of the evidence
- Brief description of evidence, when appropriate, such as “glass fragments” or “hair.” Avoid using adjectives, such as long or blonde, to describe objects being collected, such as hair; e.g., “Fibers and hair found on a denim-covered couch.”



- Label the bindle and container just before collecting an object, and seal the container immediately after collection. These actions help to protect the integrity of the sample and the chain of custody.

### Collecting Evidence

- a. Gently pick up the evidence using clean tweezers. Use only clean tweezers when collecting a piece of evidence.
- b. Grasp the evidence gently and with only sufficient force to securely collect the evidence with the tweezers. When collecting hair, be sure to capture the root of the hair when possible since DNA is contained in the hair root.
- c. Continue using the tweezers on all evidence large enough to be collected and place the evidence into the bindle or envelope. Use and label a different bindle for different apparent types of evidence, different areas of collection (as appropriate), or for other reasons.
- d. Close the bindle or envelope to contain the evidence and protect it from contamination or leakage. When closing the bindle, make sure to contain the evidence placed into it.

### Packaging

- a. Place the bindle into an envelope or other container.
- b. Close the container and seal the entire opening with evidence tape. Write your initials, identification number, and the date across the evidence tape seal.
- c. Store the sealed envelope or container.



### ***Collection Procedure: Swab a Surface***

#### ***Follow [Trace Evidence Documentation and Packaging Guidelines](#)***

For most trace evidence, all other methods should be considered superior and therefore, the most appropriate ones attempted first before using a swab to collect evidence. Often the swab collects too little of the evidence or embeds the evidence within the fibers of the swab making removal or recovery difficult for analysis. Reasonable uses for a swab exist, however, such as recovery of pepper spray from the face of a subject or dye-pack contents from a vehicle interior or hands of a subject.

### Marking Evidence

**Evidence labeling:** Label a container for the swab with your initials, identification number, the date and time, evidence number, location, and evidence description.



**Evidence number:** Each piece of evidence must have a unique number. This number should correspond to the placard next to the evidence and the evidence log as appropriate.

**Evidence description:** The evidence description includes:

- Type of evidence
- Location of the stain
- Whether the stain is wet or dry

When describing stains, use the word “apparent” or the phrase “of unknown origin” when the source of the stain is unidentified; e.g., “Brown stain of unknown origin on bathroom floor.”

- a. Label the container just before collecting the swab, and seal the container immediately after collection. These actions help to protect the integrity of the evidence and the chain of custody.
- b. If the stain is dry, moisten the cotton tip of a swab using an appropriate solvent depending on the evidence such as two or three drops of distilled water. Do not saturate the swab with solvent, just enough to “dampen” the swab with solvent. To avoid contamination, do not touch the cotton tip of the swab to any surface other than the sample area. Also ensure that the portion of the area or object with the stain has been photographed and documented in notes before proceeding.
- c. Hold the bottle of solvent above the swab. Use a minimum amount of solvent to moisten the swab: drop two or three drops of solvent on the swab.
  - Do not touch the tip of the water bottle or transfer pipette to the swab.
  - Do not saturate the swab. (It should be moist, but not dripping.)
- d. In some instances, distilled water may not place the stain in solution so a different solvent such as rubbing alcohol may need to be used. Consult with your local crime laboratory personnel for specific procedures to use.
- e. Swab the stain with the cotton-tipped end of the swab. Touch the swab gently and firmly to the stain. Rotate the swab to ensure that the stain is collected on as much of the cotton tip as possible. Do not smear the stain when swabbing it.
- f. Dry the swab.
- g. Place the swab into a container (e.g., bindle, self-made envelope, or drying box). If necessary, break off the end of the swab so the swab fits. Then, close the bindle and place it into a container.

Close the container and seal the entire opening with evidence tape. Write your initials and identification number and the date and time across the evidence tape seal.

**Control sample:** Label the control container with your initials, identification number, the date and time, evidence number, location of the control in relation to the original sample, and description of the control sample. Clearly identify this sample as a control sample (e.g., write the words “Control Sample” in bold print on the bindle).

**Control sample number:** Each piece of evidence, including the control sample, must have a unique identification. A letter or number may be appended to the original evidence number to denote the control sample; e.g., If the original evidence number was #32, the control sample could be #32.A or #32.1.

**Control sample description:** The description includes:

- Description of the stain – what is being collected.
- Location of the control sample in relation to the stain evidence
- Location of the original stain

Label the container just before collecting an object, and seal the container immediately after collection.

**Collect a control sample:** Moisten the cotton tip of the control swab(s) using the same solvent as the evidence. Hold the bottle of distilled water or transfer pipette containing solvent above the swab and drop two or three drops of water or solvent on the swab.

- Do not touch the tip of the transfer pipette with solvent to the swab.
  - Do not saturate the swab. (It should be moist, but not dripping wet or saturated.)
- a. Locate an unstained area of the same surface from which the evidence stain sample was taken. Swab the unstained area of this surface.
    - Touch the swab gently and firmly to the stain.
    - Rotate the swab to ensure that the stain is collected on as much of the cotton tip as possible.
  - b. Allow the swab to dry while continuing evidence collection. Place the dry swab into a bindle or self-made envelope. Then, place the bindle into a manila or other envelope. Close the envelope and seal the entire opening with evidence tape. Write

your initials, identification number, and the date across the evidence tape seal.

**Treat the control sample as you would treat the evidence sample.**

**Do not package control or comparison samples with evidence samples.**

### ***Collection Procedure: Soil and Rock Samples***

Follow *Trace Evidence Documentation and Packaging Guidelines*

#### **Additional Equipment Needed**

Compass; measuring tape; gardener's hand shovel; mason's trowel; screwdriver.

- Always use clean tools and individual bindles when collecting soil or rock samples.
- If an impression, print, body or other evidence is in the area, photograph and document it in notes before collecting nearby soil or rocks.
- Collect samples from the known crime scene, any "alibi" site(s) (e.g., a site that the victim or accused claims to have visited), or a "representative" site (such as a site where prints that match recovered shoes or tires are found).
- When soil is firmly attached to a movable object, collect and air dry the object before packaging it. If it cannot be collected, gently scrape samples from the object onto clean paper.
- Never package soil directly into commercially manufactured envelopes or bags.
- Always package soil in a sealable container: glass or plastic vials, bottles or jars with screw cap lids, self-made envelope, paper bindle, or other container.
- Collect minimum of three tablespoons of soil from each location. Go a little deeper than at least as deep as the evidence sample appears to have penetrated the ground soil. Usually the top layer of soil is only disturbed for the evidence sample.
- Collect a comparison sample close to the suspected or known evidence sample location and at various locations around the evidential sample up to 100 feet, attempting to include varieties of soil in the scene area. (See Figure D-14.)

- Layering of soil can be important to show recent or historical presence at a location. This is particularly true of vehicle collection. Preserve layering whenever possible.

### Documentation

Ensure that the portion of the object with the soil has been photographed and documented in notes and sketching. Include measurements of collected soil (evidence or control/comparison samples) locations.

### Marking Evidence

**Evidence labeling:** Label a container for each soil sample with your initials, identification number, the date and time, evidence number, location, and evidence description. Label each bindle, envelope, bottle, or jar with your initials, identification number, evidence number, the date and time, location, and evidence description.

**Evidence number:** Each piece of evidence must have a unique number. This number should correspond to the placard next to the evidence (evidence, control, or comparison) and the evidence log as appropriate.

**Evidence description:** The evidence description includes:

- Location of each soil sample relative to specific landmarks at the scene
- Whether the soil was wet or dry when collected
- Whether the soil contains any detectable odor or other unusual characteristics or objects
- Estimated amount of sample

When describing soil contents, use the word “apparent” or the phrase “of unknown origin” when the source of the stain/mark is unidentified; e.g., “Soil sample taken from approximately 1 foot north of apparent boot print (#6A.1).”

- a. Determine where to begin sample collection.
  1. If a victim died on the ground, and the body has not been removed, collect the sample from as close to the body as possible without disturbing it. Otherwise, prepare to collect a sample from the center of where the body laid and other appropriate locations of the body.
  2. If collecting a series of samples along the path of an impression, determine the start and end points of the path. The starting point is the place where the first impression is made and the first sample must be collected, then along the path traveled by the subject.

3. Examine the ground for trace evidence that may not have been collected.
- b. Dig straight down into the soil/rock to collect a sample of three tablespoons to one cup of the soil.
  - Be sure to start with clean digging tools. Clean the tools after each sample. Use the mason's tool, gardener's hand trowel, and screwdriver as needed to dig straight into the ground or rocks.
- c. Place the soil sample into the container (bottle, jar, vial, bindle).
  - Mix soil as little as possible, keeping in mind the potential for layering of soil.
  - To avoid contamination and leakage, it is critical that each sample is stored in its own sealed container and kept apart from other soil/rock samples and tools that were used.
- d. Collect and package the remaining samples in separate bindles. Take additional samples at distances of 1, 10, 25, and 50 feet from the original impression/impact point. [recreate the diagram below] Size of area comprising the scene will determine how far out the samples need to be taken.

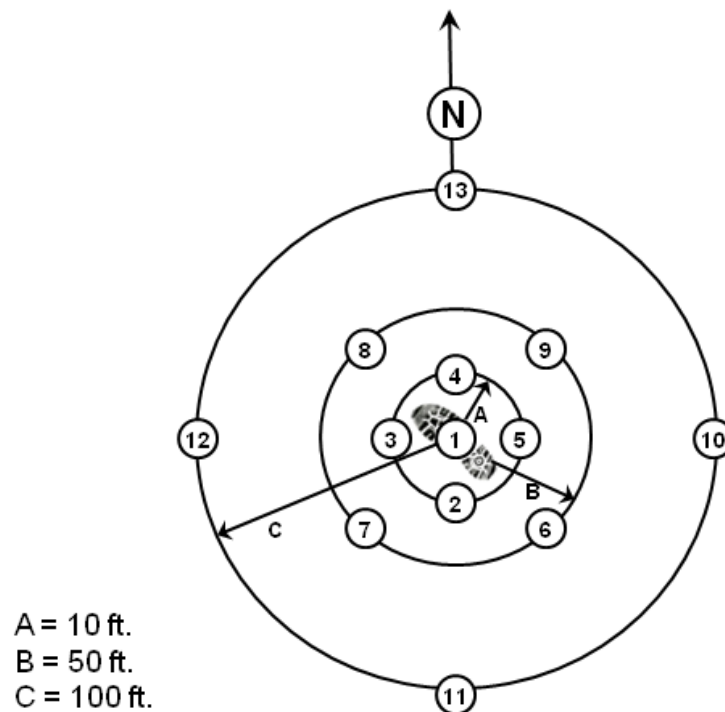

*Figure C-14. Collect soil and rock samples at regular distance intervals from the original impression.*

- Take at least four samples at varying compass points each time the distance from the initial evidence area and sampling location is increased.
  - Ensure that your notes and the label on the container include the compass direction and distance from the previous location, or the initial evidence sample, or permanent markers used for measurement in the scene. Whichever reference point is used, consistently use that point throughout.
- e. If the sample is wet, place it on a clean piece of paper in a secure location used for evidence drying, such as a drying rack, until it is dry.
- f. **If drugs or ignitable liquids are suspected, the sample must be frozen.** Contact a fire investigator or fire debris analyst if ignitable liquids are suspected.
- Keep the sample as cold/cool as possible helps to slow degradation. Natural components of some soils may degrade the composition of added chemicals in the sample.

### Packaging

Place each initial container (bottle, jar, vial, bindle) into its labeled container. Only one soil sample per container. Do not package evidence with comparison/control samples.

Close the container and seal the entire opening with evidence tape. Write your initials, identification number, and the date and time across the evidence tape seal.



Courtesy Jack Dillon

### *Gunshot Residue Collection Methods*

Follow *Trace Evidence Documentation and Packaging Guidelines*

#### Equipment Needed

Gunshot residue (GSR) collection kit or GSR collection stubs; paper envelopes; paper towels; clean paper; waterproof pen; evidence tape; powder-free protective gloves; face protection.

- Determine if the suspect(s), victim(s), or witness(es) should be tested; collect the GSR as soon as possible.
- Do NOT use tape lifts in place of a GSR kit stub.
- The instructions included in the GSR kit should always be followed.



- Sample the hands for GSR using the collection kit as soon as possible. If collection cannot be made immediately on contact with the subject, individually bag the subject's hands using paper bags and not plastic bags (as plastic may cause hands to sweat).
- Good GSR samples can generally be obtained from the web portions of the hands.
- GSR collection kits should contain materials (e.g., carbon-coated adhesive stubs or adhesive-coated discs) required to perform scanning electron microscopy (SEM) residue tests.
- Do not use GSR kits that have swabs or color tests.
- **Do not** allow the suspect(s), victim(s), or witness(es) to wash their hands or subject the hands to any liquids after the shooting, or any rubbing onto other surfaces (e.g., clothing, bag on hand, furniture, etc.).
- Keep GSR kits away from firearms evidence.
- Evidence such as vehicles can also be tested for the presence of GSR, by using the same procedure as would be used on hands.

## Footwear and Tire Impressions<sup>4</sup>



### **Tire Impression Evidence**

- A vehicle may be associated or disassociated to a crime scene by tire impressions.
- A comparison of the accident/crime scene impressions can result in an identification, inclusion or elimination of a tire.
- Impression(s) can be found in a variety of substrates including soil and snow, as well as on cement and asphalt.
- The evidentiary value of a comparison usually depends upon the quality of the impression and the manner in which it is documented and collected.

### **Casting Considerations**

The decision to cast is affected by the conditions of the substrate that the impression is in or on. Impressions in fine, humus soil, wet sand, and even snow are often excellent candidates for casting. Coarse substrates may not always be the best substrate for retaining detail of the tire impression(s). It is recommended that all impressions are

---

<sup>4</sup> See also *Guide for the Collection of Footwear and Tire Impressions in the Field*, [http://www.swgtread.org/images/documents/standards/published/01\\_field\\_collection\\_03-2005.pdf](http://www.swgtread.org/images/documents/standards/published/01_field_collection_03-2005.pdf). Accessed February 28, 2012.



impressions are photographed and cast, to recover the maximum amount of impression detail.

### Documentation<sup>5</sup>

Photography is a valuable way of collecting impression evidence for later comparison. As with all evidence, overall photographs should be taken using a standard-format lens showing the impressions in relation to the other features of the scene. It is critical that distortions are minimized by adhering to the following:

- Impression photography requires the use of a tripod and detachable flash.
- Documentation must include a photograph with a measurement scale. The scale should not be placed over or across the impression. The scale must be level with the bottom of the impression and be approximately the same size as the impression for proper documentation. The scale should contain case identification information.
  - Case number
  - Orientation
- Documentation should indicate the direction of travel, if this can be determined.
- The camera should be mounted on a tripod directly over the impression, with the film plane parallel to the impression.
- The impression should be shaded from direct sunlight.
- It is recommended that the detachable flash or other light source be at an angle of 45 degree or less depending on the depth of the impression. A variety of flash angles are recommended. These oblique light photographs should be taken with the direction of the flash coming from at least 3 different directions around the impression.
- Tire impressions are photographed in an overlapping series that should continue the length of the impression in which detail is present.
  - Each frame should overlap by approximately 20%, and no more than two feet should appear in each frame. A scale or

---

<sup>5</sup> See also *General Guidelines for Photographing Tire Impressions*, <https://www.swgjit.org/pdf/Section%209%20General%20Guidelines%20for%20Photographing%20Tire%20Impressions?docID=53>. Accessed February 29, 2012

tape measure placed the length of the track will help reconstruct the length of the entire impression from the separate photographs.

**Single-lens reflex or similar cameras with changeable lenses should be used for capturing impression evidence.**

### ***Tire Vehicle Measurements***

The following measurements should be recorded:

- The track width of a vehicle is the distance between the center of the tire mounted on one side of the vehicle to the center of the tire on the opposite side. The front and rear track widths may be different.
- The wheelbase of a vehicle is the distance between the center of the front axle and the center of the rear axle.

### ***Tire Impression Measurements***

Measure the track width and wheelbase recorded in the impressions, if possible:

- The track width may be measured from the inside of one tire track to the outside of the adjacent tire track, if they can be determined to be a pair made by a single vehicle.
- If the positions of the front and rear tires can be determined where a vehicle stopped, these positions can be measured to determine an approximate wheelbase measurement.

### ***Casting*** (see *Cast an Impression*)

After photography, casting may be performed to document the impression in three-dimensional form. The decision to cast is affected by the substrate conditions and other environmental factors.

- Impressions should be photographed before casting.
- Do not remove soil adhering to the cast or attempt to clean the cast after recovery as this may damage cast detail.
- Place each casting in a protective, breathable container after drying.

### **Enhancements/Optimization**

Chemicals and/or powders may be used to enhance or optimize impression(s). It should be determined prior to chemical application if a sampling of the blood is required, as the chemicals used to optimize the impression(s) may interfere with DNA analysis.

- **Forensic light sources** may optimize visualization and photography of the impression(s).
- Examination of the impression(s) using a forensic light source may be conducted prior to applying any chemicals or powders.
- Blood does not fluoresce, but views as black in **infrared (IR) range** and may offer contrast between the impression and the substrate of the item it is on.



Courtesy of Rebecca Carter

### Footwear Impression Evidence

- A shoe or boot may be associated or disassociated to a crime scene by footwear impressions.
- A comparison of the crime scene impressions can result in an identification, inclusion or elimination of a footwear **outsole**.
- Impressions can be found in soil, snow, on counters, tile floors, doors, wood and vinyl furniture, paper items, as well as other surfaces.

The decision to cast an impression is affected by the conditions of the substrate the impression is in or on. Impressions in fine, humus soil and even snow are often excellent candidates for casting. Coarse substrates may not always be the best substrate for retaining detail of the tire impression(s). It is recommended that all impressions are photographed and cast, to recover the maximum amount of impression detail.

#### **Documentation** (also see *Photography*)

Photography is a valuable way of collecting impression evidence for later comparison. The evidentiary value of a comparison usually depends upon the quality of the impression and the manner in which it is documented and collected.

Overall photographs should be taken using a standard-format lens showing the impressions in relation to the other features of the scene. It is critical that distortions are minimized by adhering to the following:

- Impression photography requires the use of a tripod and detachable flash.
- Documentation must include a photograph with a measurement scale.
- The scale should not be placed over or across the impression.
- The scale must be level with the bottom of the impression and be approximately the same size as the impression for proper documentation.

- The scale should contain case identification information:
  - Case number
  - Orientation
- The camera should be mounted on a tripod directly over the pattern, with the film plane parallel to the impression.
- The impression should be shaded from direct sunlight for flash photographs.
- It is recommended that the detachable flash or other light source should be at an angle of 45 degrees or less depending on the depth of the impression. A variety of flash angles are recommended. These oblique light photographs should be taken with the direction of the flash coming from at least 3 different directions around the impression.
- The entire impression should be captured in one frame unless overlapping photographs are needed to capture sufficient resolution.

**Single-lens reflex or similar cameras with changeable lenses should be used for capturing impression evidence.**

### ***Casting*** (see *Cast an Impression*)

After photography, casting may be performed to document the impression in three-dimensional form. The decision to cast is affected by the substrate conditions and other environmental factors. Impressions should be photographed before casting.

- Do not remove any soil adhering to the cast or attempt to clean the cast after recovery as this may damage cast detail.
- Place each casting in a protective, breathable container after drying.

### **Two-dimensional Impressions**

Two-dimensional impressions are usually a deposit or removal of material to or from a surface. These may be found on paper items, doors, counters, tile floors, and other hard surfaces/substrates. There are generally two ways footwear impressions are made:

- by the removal of dust or other material from a surface by adhering to an outsole leaving a void (negative) impression

- the deposition of a material or contaminate such as blood, dirt, and oil present on a footwear outsole, transferred to a surface, leaving an impression

If possible, submit the entire item that has the impression on it. If that is not practical, the impressions may be lifted using various techniques such as:

- Electrostatic dust lifter
- Gel print lifter
- Tape or clear adhesive material (if no other material is available)

### Enhancements/Optimization<sup>6</sup>

Chemicals and or powders may be used to enhance or optimize impression(s). It should be determined prior to chemical application if a sampling of the blood is required, as the chemicals used to optimize the impression(s) may interfere with DNA analysis.

Forensic light sources may optimize visualization and photography of the impression(s). Examination of the impression(s) using the forensic light source may be conducted prior to applying any chemicals or powders. It should be noted that blood does not fluoresce, but views as black in IR range and may offer contrast between the impression and the substrate of the item it is on.



### ***Collection Procedure: Cast an Impression<sup>7</sup>***

Casting an impression should only be attempted by someone trained and experienced in the technique employed.

### Equipment Needed

Casting kit (dental stone); mixing container (such as a heavy duty baggie or a bucket); stirring stick; material for forms; water; packaging materials; waterproof pen; evidence tape; measuring tape/ruler; identification labels; protective gloves; face protection.

### Documentation

***Properly photograph*** the impression before casting.

---

<sup>6</sup> See also *SWGTHREAD Guide for the Detection of Footwear and Tire Impressions in the Field*, [http://www.swgtread.org/images/documents/standards/published/03\\_field\\_detection\\_03-2005.pdf](http://www.swgtread.org/images/documents/standards/published/03_field_detection_03-2005.pdf). Accessed February 28, 2012.

<sup>7</sup> See also [http://swgtread.org/images/documents/standards/published/01\\_field\\_collection\\_03-2005.pdf](http://swgtread.org/images/documents/standards/published/01_field_collection_03-2005.pdf), accessed June 18, 2012.

### Marking Evidence

**Evidence labeling:** Label a container for the object with your initials and identification number, the date and time, evidence number, location, and evidence description.

**Evidence number:** Each impression must have a unique number. This number should correspond to the placard next to the evidence.

**Evidence description:** The evidence description includes:

- Type of item being cast
- Location of the item being cast
- Orientation of the impression to north, to a feature of the object with the impression on it, or to a nearby object

### Casting the Evidence

- When making a cast, be prepared to act quickly and methodically. Time is often a critical factor in successfully making a cast.
- When casting tire impressions, cast as much of the tire impression as possible.
- Use dental stone for casting in dirt, soil and sand as well as snow. Sulfur may be used for casting in snow.
- Impression coating materials such as SnowPrint Wax, stabilizers (e.g., hairspray) and highlighters (e.g., paint) may be used depending upon conditions present.
- Casts should be marked with the impression identifier, general evidence collection information (date, case number, etc.) and with a directional indicator.
- Casting material should be allowed to thoroughly harden before removal from surface.
- Prepare the casting material. Follow the manufacturer's instructions for preparing the casting material.
- A sturdy plastic bag is used for mixing dental stone for footwear impressions, a bucket is usually necessary for mixing casting material for tire tracks.
- The initial pour of the casting material should occur off the impression to avoid damaging detail; the casting material should be allowed to flow into the impression.

### Casting impressions with dental stone in soil and sand:

- a. If necessary, prepare impressions for casting:



1. When casting a fragile impression, it may be necessary to apply a fixative. Care should be exercised when applying fixatives to minimize any possibility of damage to the impression.
  2. When casting in dense soils, it may be necessary to apply a release agent. Care should be exercised when applying release agents to minimize any possibility of damage to the impression.
- b. Add appropriate amount of water to pre-measured amount of dental stone. The average footwear impression requires approximately two (2) pounds of dental stone and approximately ten (10) ounces of water. The amount of water required may vary depending on the casting product. The resulting mixture should have the viscosity of heavy cream. The viscosity of the mixture may need to be adjusted based upon the nature of the impression.
  - c. Mix continuously for a minimum of 3-5 minutes so that the powder can thoroughly absorb the water.
  - d. Pour casting material carefully outside the perimeter of the impression and direct the flow into the impression. Ensure the impression is completely filled and/or covered evenly. In the event that the casting material does not flow completely into the impression, the top surface of the casting material can be agitated to help it flow. Casts should be of sufficient thickness to avoid breakage. If necessary, additional casting material may be poured over the top of the original cast to complete the cast and/or add thickness.

**For fragile and shallow impressions:** pour casting material from outside the perimeter so that it rapidly flows over the impression. A thinner mixture of casting material is necessary for this technique. Avoid pouring directly onto the uncovered impression.

*Note:*

- Larger quantities of dental stone can be mixed in a bucket to cast large segments of tire impressions.
- Impressions under water may be cast using dental stone and specialized techniques.

**Casting impressions with dental stone and sulfur in snow:**

- a. If necessary, prepare impressions for casting. It is noted that snow varies considerably in texture and type. Application of highlighting materials (such as Snow Print Wax™ or aerosol



- paints) may be advantageous during photography. These materials may or may not be necessary for the casting process.
- b. To increase the contrast of the detail, a thin application of highlighting spray may be directed at the impression from an oblique angle. The application of highlighting sprays to the snow impression may increase melting; therefore, the impression may need to be shielded from the sun until it can be photographed and cast.
  - c. A thick application of SnowPrint Wax™ may be applied if needed before using the dental stone casting material.
  - d. Casting with dental stone:
    1. Add a heaping tablespoon of Potassium Sulfate to the pre-weighed bag of dental stone.
    2. Add snow to the water source and place the bags of dental stone in the snow to pre-cool the ingredients.
    3. Add the appropriate amount of water to the pre-measured dental stone. A thicker mixture should be used for snow.
    4. Pour the casting material from outside the perimeter and direct the flow into the impression. The surface of the casting material can be agitated to help it flow.
  - e. Casting with sulfur:
    1. Snow impressions may be cast using sulfur; however, it is recommended that specific training in this technique be acquired before using.

### Packaging

- a. Collect and package debris that may have fallen from the cast when it was removed.
- b. Store the packaged debris with the cast.
- c. Do not clean the cast.
- d. Package the debris in a bundle or other container that will securely store it. Label the container with your name, identification number, and the date and time. Place the cast into the labeled container. When necessary, use shock absorbing and protective materials to cushion the cast.
  1. A cast is delicate and can be easily damaged. Package the cast so that it is stable and secure and the face of the impression is up and protected from disturbance during transport.

2. If a cast is too large to box, wrap it in clean paper and shock-resistant material (such as bubble-wrap). The goal is to seal the impression and protect it from damage during transport.
- e. Never discard a cast, regardless of condition when removed from the impression. Be sure to save and submit all casts to the laboratory. Even a broken cast may be useful during the examination process.
  - f. Close the container and seal the entire opening with evidence tape. Write your initials and identification number, and the date and time across the evidence tape seal.
  - g. Make sure that the container is labeled with a description of the item cast, your initials and identification number, the date and time, location and, when possible, evidence number.



### ***Collection Procedure: Lifting Dust Footwear Impressions<sup>8</sup>***

#### Equipment Needed

Fingerprinting kit (fingerprint powder, soft-bristled brush, lifting tape); contact paper and clear acetate; electrostatic dust lifter; adhesive and gelatin lifting materials; Mikrosil™ or other polyvinylsiloxane (PVS) casting materials; flashlight and other available light sources; clean wrapping paper; envelopes; waterproof pen; evidence tape; measuring tape/ruler; identification labels; protective gloves; face protection.

- Photograph the impression before collecting or removing it.
- An ***electrostatic dust lifter*** is appropriate to use only when the impression is left in dry dust.
- Whenever possible to do so without damaging the impression, collect the object containing the impression.
- Always use clean gloves when handling evidence.
- Always collect soil/rock samples from the immediate surrounding area when the impression is on the ground.

#### Documentation

***Properly photograph*** the impression before lifting.

---

<sup>8</sup> See also

[http://swgtread.org/images/documents/standards/published/12\\_lifting\\_03-2007.pdf](http://swgtread.org/images/documents/standards/published/12_lifting_03-2007.pdf) Accessed June 20, 2012.

### Marking Evidence

**Evidence labeling:** Label a container and an identification label for the developed impression with your initials and identification number, the date and time, evidence number, location, and evidence description.

Make sure that the information on the container matches the identification labels.

**Evidence number:** Each piece of evidence must have a unique number. This number should correspond to the placard next to the evidence.

**Evidence description:** The evidence description includes:

- Type of print collected
- Location of the impression
- Orientation of the impression to north, or to a feature of the object with the impression on it, or to a nearby object

Label the container just before collecting an object, and seal the container immediately after collection.

### Lifting the Impression

When lifting impressions, examiners should use the least destructive method first. If in doubt, treat all impressions as dry-origin and apply the methods listed below. If unsuccessful, attempt collection as indicated for wet-origin impressions. All procedures shall be performed when applicable and noted when appropriate. The order and use of these individual techniques is determined by considerations such as substrate, components of the impression, and environmental conditions.

#### Electrostatic dust lifter

Electrostatic lifting is useful for the detection and lifting of dry-origin dust and residue impressions that are the result of tracking from dry, dirty surfaces onto relatively cleaner surfaces. Electrostatic lifting is normally the first technique used, as unsuccessful attempts will not prevent subsequent lifting and enhancement techniques. There are a number of electrostatic lifters available. Consult the manual provided by the manufacturer for specific operating instructions.



All of these devices utilize a film which has a black side and an aluminum-coated side. The black side of the film is placed against the impression, and a high-voltage charge is applied to the film, resulting in the transfer of the dry dust or residue impression.



- To visualize the lifted impressions, the lifts should be examined in a darkened room with a high-intensity light source held at an oblique angle to the surface of the lift.
- The lifting film should never be reused.
- Smaller lifts can be stored in individual clean file folders. These folders should never be reused.
- Larger lifts can be stored by carefully rolling with the aluminum side out. After rolling, the edge can be secured with a small piece of tape.
- Electrostatic lifts are fragile and impressions can be destroyed by any wiping action across the surface of the lift. Consideration should be given to photographing lifts prior to packaging. Electrostatic lifts retain a charge and should never be packaged in cardboard, cardboard boxes, or plastic bags.

### Adhesive and gelatin lifters

- Footwear-size adhesive and gelatin lifters are used for the lifting of dust and residue impressions, wet-origin impressions, as well as impressions developed with fingerprint powder.
- Gelatin lifters are available in white, black and clear. White lifters provide greater contrast with impressions enhanced with dark-colored powders. Black lifters provide greater contrast with light-colored powders and residue impressions. Clear lifters normally do not provide good contrast. Gelatin lifts of residue impressions should be photographed as soon as possible after collection.
- Adhesive lifters are available in white and clear. They include footprint-sized sheets and various widths of rolled tapes. White backgrounds are recommended for clear adhesive. Clear adhesive on a clear background is not recommended for residue impressions, these lifts are normally used for impressions developed with dark-colored powders. Residue or powdered impressions may also be lifted with tape if other lifting material is not available. Sections of tape may be overlapped and lifted as a single lift to recover the entire impression intact. The tape-lifted impression should be placed on a contrasting or white background. Rolled tapes are available in five-inch widths and are preferred to narrower tapes.
- Dental Stone can be used to lift impressions such as mud and tire residues from surfaces such as concrete and tile. Refer to the “Guide for Casting Footwear and Tire Impression Evidence” for mixing instructions. A thick layer of dental stone can be poured over the impression area and lifted when dry. Note that a border of cardboard or other material should be placed around the impression to aid the lifting of the dental stone after drying.
- Mikrosil™ or other polyvinylsiloxane (PVS) casting materials can be used to lift impressions enhanced with powder, from any surface. These products lift the complete powdered impression and are particularly useful on textured surfaces.

### Packaging

- a. Insert the lifted impression into the labeled envelope.
- b. Do not bend or fold the lifted impression to fit it into the envelope.

- c. Close the envelope in which the print is stored and will be transported, and seal the entire opening with evidence tape. Write your initials and identification number, and the date and time across the evidence tape seal.



## Motor Vehicles

### *Procedure: Examine a Motor Vehicle*

#### Equipment Needed

Boundary markers (rope, tape, cones, etc.); clean paper bags, boxes or envelopes; evidence tape; waterproof pen.

- Process a vehicle with the same caution and detailed approach as you would any crime scene. Obtain warrants as you would other crime scenes if required.
- Establish well-defined boundaries around the vehicle using boundary markers (such as rope, tape, cones, etc.) to preserve evidence.
- Photograph the interior and exterior of the vehicle; including the vehicle identification number (VIN). Consider exterior photography from all four corners of the vehicle, towards the center of the vehicle.
- Collect DNA, fingerprint or trace evidence before moving the vehicle to avoid damaging or losing it when the vehicle is moved.
- Examine exterior surfaces for latent prints including the side mirrors, fenders (when a wheel is missing), and the six-inch-wide areas surrounding the sides, hood, trunk, and roof support post.
- Examine interior surfaces for latent prints including door handles, rear-view mirror, seat belt buckles, windows and window handles/buttons, stick shift knob, and glove box door.





- Tow the vehicle to a well-covered, dry, secure area, such as a police compound, when a detailed search for evidence is required.
  - Take steps to ensure that any evidence that can fall from the vehicle during towing can be retained; e.g., placing a tarp below the car or stabilizing bullet holes in glass with tape.
- Maintain and continue to protect the boundary around the vehicle until it is towed.

### Documentation

Record critical information about the vehicle before it is moved. Information to record in your notes includes:

- Odometer reading
- Gas level
- Apparent damage
- State of windows, head and tail lights, turn signal lights and mirrors
- Ambient temperature and radiator/hood temperature
- Possible reason for vehicle being at the location

Whenever appropriate, wrap all stray vehicle parts related to the vehicle in clean paper. Lay the object on the paper and fold the paper around it.

### Marking Evidence

**Evidence labeling:** Label the container for the object with your initials and identification number, the date and time, evidence number, location, and evidence description.

**Evidence number:** Each piece of evidence must have a unique number. This number should correspond to the placard next to the evidence.

**Evidence description:** The evidence description includes:

- Type of item
- Location of the item found
- The proximity of the item to the vehicle

Label the container just before collecting an object, and seal the container immediately after collection.



### Packaging

- a. Place the wrapped object into the labeled container. Some objects, such as tires, may be transported without placing into another container. If the object will not fit into a container, seal the paper wrapping the object with evidence tape.
- b. Close the container and seal the entire opening with evidence tape. Write your initials and identification number, and the date and time across the evidence tape seal.
- c. Seal the openings of the vehicle with evidence tape. It is important to seal the vehicle by taping exterior parts of the vehicle that can be opened with evidence tape.
- d. Avoid applying tape to areas that might be or are known to contain evidence that could be damaged when touched. When the weather is inclement, cover the necessary areas with a clean, weather-resistant material, such as plastic.
- e. The vehicle should be accompanied to a secured storage facility.
- f. When the vehicle arrives at its destination, sign the evidence log to verify that the vehicle was checked into the storage facility, then check that all seals on the vehicle are intact.
- g. When seals are broken, note when the break occurred and reapply evidence tape to secure the vehicle.



### Electronic and Digital Evidence<sup>9</sup>

Computers and other electronic devices are often found at crime scenes and may contain evidence of criminal wrongdoing. This evidence includes:

- Media
- Networked computers
- Non-networked computers
- Wireless phones and tablet computers
- Other devices

#### ***Procedure: Loose media***

Electronic media, in this context, are objects on which digital data can be stored. They include storage media such as hard drives, compact disks (CDs), digital video disks (DVDs), “floppy” disks, audio and video cassette tapes, and USB flash drives. They also

<sup>9</sup> See also *Best Practices for Computer Forensics*, <https://www.swgde.org/documents/Current%20Documents/2006-07-19%20SWGDE%20Best%20Practices%20for%20Computer%20Forensics%20v2.1> Accessed 11-14-2012

include objects like smart cards (such as some credit cards) and memory cards such as Secure Digital (SD) cards, Mini or Micro SD cards, Compact Flash Cards, and xD cards. Common brand names are Kingston®, SanDisk® and Lexar®.

### Equipment Needed

Anti-static bags, bubble-wrap and other packing materials; clean paper bags, boxes, or envelopes; evidence tape; flashlight; waterproof pen; labels; personal protective equipment.

### Precautions for seizing:

- Electronic evidence is fragile and sometimes includes time-sensitive data of investigative value that is stored on or transmitted by electronic devices.
- Handle electronic evidence carefully because it is fragile. It can be easily damaged by heat, cold, shock or magnetic fields.
- Do not handle contacts, bend connections, and expose media to extreme heat/cold or magnetic fields.
- Do not use destructive techniques, such as applying fingerprinting chemicals while collecting the electronic evidence.
- Do not try to view the contents of electronic evidence without assistance from a qualified analyst.

Determine whether electronic media is present; it may or may not be associated with the visible computer or other electronic equipment, such as DVD or video player. Electronic media is small, can be easily hidden, and is sometimes camouflaged to appear as a non-electronic object.

Use these methods to locate media:

- Interview people at the scene or informants.
- Examine monitors, keyboards, and mice for media slots.
- Examine key rings, desk mat/pad, game machines (Xbox®, PS2™) and telephones for media.
- Search vehicles, toys, cameras, TVs, and any personal electronic device.
- Look for common types of media, such as DVDs, CDs, cassette tapes in drawers, boxes, closets.
- Look for smart cards (card appearance is similar to a credit or ATM card), especially when different names are on several cards found together.
- Examine desk areas completely for usernames, passwords, and email accounts.

Fulfill the legal requirements necessary for seizure of electronic media by contacting the appropriate authorities to obtain legal advice and warrants, as needed.

To determine legal requirements, follow departmental regulations while establishing whether there is probable cause to collect:

- Hardware
- Software
- Data
- Cell Phones

Identify whether a warrant is needed or there is an exception to the warrant requirement.

When the media is inside of a computer or other electronic component, do not remove it without the assistance of an electronic evidence collection expert. When the state of the computer or other electronic component is disturbed:

- Data can be lost or damaged.
- Files can be modified (e.g., creation dates/times).
- The computer can be damaged.
- Legitimate business can be disturbed.
- Liability for officer and department can be created.

### Documentation

When the media is readily accessible, document it as it was found before collecting it. Photograph the media as found using standard crime scene photographic techniques (overall, mid-range and close-up).

Photograph all connections (network cables, power cables, and peripheral cables) to the device as you found them.

Sketch a diagram of the placement of the media in the area and relative to devices, equipment, and objects. Sketch and label the cable connections to the device prior to collection.

Record information that supports the photograph, including:

- Type of media
- Media location
- Media appearance/condition, including visible damage or other characteristics
- Media storage capacity (e.g., SanDisk® 256MB)
- Serial or other identifying numbers

### Marking Evidence

**Evidence labeling:** Prepare a label and apply it to the electronic media prior to packaging if practical. Include your initials and identification number, the date and time, evidence number, location and evidence description. Do not obscure serial numbers or manufacture's labels with the evidence label.

**Evidence number:** Each piece of evidence must have a unique number. This number should correspond to the numbered placard photographed and diagramed next to the evidence.

**Evidence description:** The evidence description includes:

- Media type
- Media location
- Media appearance/condition, including visible damage or other characteristics
- Media storage capacity
- Serial or other identifying number

Handle electronic evidence with care. Do not use destructive techniques, such as applying fingerprinting chemicals, while collecting the electronic evidence. Do not expose electronic media to extreme heat, cold, or magnetic fields.

### Packaging

- a. Package media to prevent the loss of data. Protect it from shock, bending, tearing, scratching and magnetic exposure. Use plastic bubble-wrap or foam pads as packing material when original packing materials are not available. Do NOT use Styrofoam as it creates static charges.
- b. When the media requires fingerprinting, do not wrap it.
- c. Place the media into the labeled container.
- d. When transporting electronic media, attach a label indicating:
  1. FRAGILE
  2. SENSITIVE ELECTRONIC MEDIA
  3. KEEP AWAY FROM MAGNETIC FIELDS
- e. Close the container and completely seal the opening with evidence tape. Write your initials, identification number, and the time and date across the evidence tape seal.
- f. Store electronic media in a secure area in a controlled climate away from magnetic sources, dust, and other contaminants.

- g. Electronic media can be damaged when stored in areas where temperatures and humidity vary significantly.

### ***Procedure: Networked Computers***

The seizure of networked computers presents unique challenges. Always consult with a qualified computer forensic analyst or network administrator before shutting down and seizing a networked system. If possible, work with the administrator of the system you are trying to seize. He/she will be the best resource to safely access and image media. Due to the size and complexity of modern computer networks, seizure is frequently not possible. Be prepared for extended time on site to logically or physically image media.

When dealing with networked devices the amount of time it takes to secure the network and data is critical. By design many of these devices can be accessed from offsite and critical evidence can be remotely destroyed, copied, or encrypted.

### **Equipment Needed**

Hand truck; cable tags and ties; rubber bands; non-magnetic flat-blade and Philips-type screwdrivers; hex and Star-type nut drivers; needle-nose and standard pliers; secure-bit drivers; small tweezers; wire cutters; anti-static bags, bubble-wrap and other packing materials; packing tape; paper bags and sturdy boxes; magnifying glass; evidence tape; flashlight; printer paper; CDs and 3½-inch diskettes; mobile phone; waterproof pen; labels; personal protective equipment.

- Electronic evidence is fragile and sometimes includes time-sensitive data of investigative value that is stored on or transmitted by electronic devices.
  - Handle electronic evidence carefully because it is fragile. It can be easily damaged by heat, cold, shock or magnetic fields.
  - Do not use destructive techniques, such as applying fingerprinting chemicals, before you examine the electronic evidence.
  - Federal and state laws regarding the interception of messages exist. State laws vary.
- a. Contact an electronic evidence collection expert as soon as discovering computer equipment and related components (e.g., desktop or laptop computer, printer, disk drive). Never move or alter the state of electronic hardware without first talking with an electronic evidence collection expert.
  - b. Look for proprietary software. Depending on the investigation, proprietary software such as database or financial software may

- have been used by the suspect. Seizure of the original software may be critical for the computer forensic analyst's investigation.
- c. Fulfill the legal requirements necessary for network seizure by contacting the appropriate authorities to obtain legal advice and warrants, as needed.
  - d. To determine legal requirements, follow departmental regulations while establishing whether there is probable cause to collect:
    - Hardware
    - Software
    - Data
  - e. Identify whether a warrant is needed or there is an exception to the warrant requirement.
  - f. Determine whether the computer equipment is stand-alone (i.e., not attached to a network) or attached to a network. Use these methods to locate a network:
    - Interview people at the scene, or informants.
    - Look for multiple computers in the area.
    - Determine whether a printer is in the area.
    - Look for cables or connectors linking a computer, card scanner, fax machine, etc., to each other, to a phone jack or phone, to a printer, etc.
    - When a laptop is present, look for a network cable or a USB modem from a cell carrier's network (Verizon, ATT, Sprint) in a USB port.
    - If no cables or USB modem are apparent and multiple devices are in the area, consider that a wireless network (WiFi) may be present. Work closely with an electronic evidence collection expert in this situation.
  - g. Establish whether the evidence will be processed on- or off-site and make the necessary arrangements. Determine whether components or data will be damaged or degraded if the network is moved.
  - h. Determine whether an outside electronic evidence collection expert is needed and available to:
    - Remove the network components or provide instructions on how to remove them.

- Conduct the network and data investigation or provide instructions on how to do so.
- i. Maintain the state of the computer components as found until after documentation is complete and after being directed to do otherwise.
- j. Until there is an electronic evidence collection expert advising, do not disturb the network components. Whether the hardware was ON or OFF when found, leave it in that state. Never turn off power to the hardware (such as a computer, printer, phone) without:
  - Being advised to do so by an electronic evidence collection expert.
  - Following shutdown procedures for that piece of hardware (locate and use documentation when needed).
- k. If it is determined that the device is running low on battery power, work with the expert to resolve this situation.

### Documentation

- a. Document the state of the machine as it was found using photography, sketching, and note-taking.
- b. Photograph the screen, the back of the computer, and the connections to other equipment (e.g., printer, external drive).
- c. Sketch a diagram of the connections between the computer and other equipment.
- d. Record information that supports the diagram and photographs, including the state of the computer, existing connections, and:
  - Equipment type
  - Equipment location
  - Equipment appearance/condition, including visible damage or other characteristics
  - Serial numbers
- e. When preparing a computer for packaging, label the cable with the port and evidence numbers before removing the cable from the port.
- f. Starting in the upper left corner of the device, assign each port a number (e.g., Port 1). Write the port number and evidence number on a label or piece of tape and adhere it to the cable.
- g. Do the same for the other end of the cable. If the other end of the cable is plugged into the wall, indicate this.



- h. After each cable is removed from a port, label the port with the assigned port number. Write the port number on a label or piece of tape. After the cable is removed from the port, place the label or tape over the port.

### Marking Evidence

**Evidence labeling:** Place a label on each component that will be collected. Include your initials and identification number, the date and time, evidence number, and evidence description. Most often, only central processing units (CPUs) and the internal and external storage media (such as hard drives, CDs, or DVDs) are collected.

**Evidence number:** Each piece of evidence must have a unique number. This number should correspond to the numbered placard next to the evidence.

**Evidence description:** The evidence description includes:

- Equipment type
- Equipment location
- Equipment appearance/condition, including visible damage or other characteristics
- Serial number

When a component is large, such as a monitor, and/or needs to be fingerprinted, only attach a tag directly to it unless the lead investigator provides the direction to place it in a transport container.

When practical, wrap each component with anti-static or other protective material. Wrap items to protect them from physical damage and from loss of data due to magnetic exposure.

When a component needs to be fingerprinted, do not wrap it.

### Packaging

- a. Place the component into the labeled container.
- b. Package items to protect them from damage due to dropping or other physical impacts and from loss of data due to magnetic exposure:
- c. Use large, plastic bubble-wrap or foam pads as packing material when original packing materials are not available.
- d. **Do not** use Styrofoam as it creates static charges.
- e. Protect internal storage from data loss (e.g., keep the CPU away from magnetic sources such as radios, heated seats, speakers).
- f. CPUs and hard drives should be packaged to protect fingerprints and transported upright, in a position that prevents movement while traveling.

- g. Monitors should be packaged and transported in a secure manner while protecting the screen and fingerprints.
- h. Close the container and completely seal the opening with evidence tape. Write your initials and identification number and the time and date across the evidence tape seal.
- i. When transporting fragile computer components, label the outside of the transport container with handling instructions.
- j. When transporting a CPU or hard drive, attach a label indicating:
  - THIS END UP
  - FRAGILE
  - SENSITIVE ELECTRONIC EQUIPMENT
  - KEEP AWAY FROM MAGNETIC FIELDS
- k. Some data may be lost if battery power ceases while the related computer components are in storage. Inform the necessary personnel of computer components that rely on battery power so that they can be maintained. When seizing laptops, tablet computers, and other battery powered devices, make every effort to locate and seize the power cables for the device.
- l. Store computer components in a secure area, in a controlled climate away from magnetic sources, dust, and other contaminants.
- m. Computer components can be damaged when stored in areas where temperatures and humidity vary significantly.

### ***Procedure: Non-networked Computers***

#### **Equipment Needed**

Hand truck; cable tags and ties; rubber bands; non-magnetic flat-blade and Philips-type screwdrivers; hex and Star-type nut drivers; needle-nose and standard pliers; secure-bit drivers; small tweezers; wire cutters; anti-static bags, bubble-wrap and other packing materials; packing tape; paper bags and sturdy boxes; magnifying glass; evidence tape; flashlight; printer paper; CDs and 3½-inch diskettes; mobile phone; waterproof pen; labels; personal protective equipment.

- Electronic evidence is fragile and sometimes includes time-sensitive data of investigative value that is stored on or transmitted by electronic devices.
- Handle electronic evidence carefully because it is fragile. It can be easily damaged by heat, cold, shock or magnetic fields.

- Do not use destructive techniques, such as applying fingerprinting chemicals, before you examine the electronic evidence.
- Federal and state laws regarding the interception of messages exist. State laws vary.
- a. Contact an electronic evidence collection expert as soon as discovering computer equipment and related components (e.g., desktop or laptop computer, printer, disk drive). Never move or alter the state of electronic hardware without first talking with an electronic evidence collection expert.
- b. Look for proprietary software. Depending on the investigation, proprietary software such as database or financial software may have been used by the suspect. Seizure of the original software may be critical for the computer forensic analyst's investigation.
- c. Determine whether the computer equipment is stand-alone (i.e., not attached to a network) or attached to a network.
- d. Use these methods to locate a network:
  1. Interview people at the scene or informants.
  2. Look for multiple computers in the area.
  3. Determine whether a printer is in the area.
  4. Look for cables or connectors linking a computer, card scanner, fax machine, etc., to each other, to a phone jack or phone, to a printer, etc.
  5. When a laptop is present, look for a network cable or a USB modem from a cell carrier's network (Verizon, ATT, Sprint) in a USB port.
  6. If no cables or USB modem are apparent and multiple devices are in the area, consider that a wireless network (WiFi) may be present. Work closely with an electronic evidence collection expert in this situation.
- e. Fulfill the legal requirements necessary for seizure of the computer and related hardware and software by contacting the appropriate authorities to obtain legal advice and warrants, as needed.
- f. To determine legal requirements, follow departmental regulations while establishing whether there is probable cause to collect:
  - Hardware
  - Software

- Data
- g. Identify whether a warrant is needed or there is an exception to the warrant requirement.
- h. Establish whether the evidence will be processed on- or off-site and make the necessary arrangements. Determine whether components or data will be damaged or degraded if the computer is moved.
- i. Determine whether an outside electronic evidence collection expert is needed and available to:
  - Remove the computer or provide instructions on how to remove it.
  - Conduct investigation of the computer and related components or provide instructions on how to do so.
- j. Maintain the state of the computer components as found until after documentation is complete and after being directed to do otherwise.
- k. Until there is an electronic evidence collection expert advising, do not disturb the network components. Whether the hardware was ON or OFF when found, leave it in that state. Never turn off power to the hardware (such as a computer, printer, phone) without:
  - Being advised to do so by an electronic evidence collection expert.
  - Following shutdown procedures for that piece of hardware (locate and use documentation when needed).
- l. If it is determined that the device is running low on battery power, work with the expert to resolve this situation.

#### Documentation

- a. Document the state of the machine as it was found using photography, sketching, and note-taking.
- b. Photograph the screen, the back of the computer, and the connections to other equipment (e.g., printer, external drive).
- c. Sketch a diagram of the connections between the computer and other equipment.
- d. Record information that supports the diagram and photographs, including the state of the computer, existing connections, and:
  - Equipment type
  - Equipment location

- Equipment appearance/condition, including visible damage or other characteristics
  - Serial numbers
- e. When preparing a computer for packaging, label the cable(s) with the port and evidence numbers before removing the cable(s) from the port(s).
- Starting in the upper left corner of the device, assign each port a number (e.g., Port 1). Write the port number and evidence number on a label or piece of tape and adhere it to the cable.



- Do the same for the other end of the cable(s). If the other end of the cable is plugged into the wall, indicate this.
- After each cable is removed from a port, label the port with the assigned port number. Write the port number on a label or piece of tape. After the cable is removed from the port, place the label or tape over the port (see photo, next page).



### Evidence Marking

**Evidence packaging:** Place a label on each component that will be collected. Include your initials and identification number, the date and time, evidence number, and evidence description.

Most often, only central processing units (CPUs) and the internal and external storage media (such as hard drives, CDs, or DVDs) are collected.

**Evidence number:** Each piece of evidence must have a unique number. This number should correspond to the numbered placard next to the evidence.

**Evidence description:** The evidence description includes:

- Equipment type
- Equipment location
- Equipment appearance/condition, including visible damage or other characteristics
- Serial number

Label a container for each component. Include your initials and identification number, the date and time, evidence number, and evidence description.



- When a component is large, such as a monitor, and/or needs to be fingerprinted, only attach a tag directly to it unless the lead investigator provides the direction to place it in a transport container.
- Whenever possible, use the original packing materials, including the fitted padding. Otherwise, use sturdy cardboard containers.
- When practical, wrap each component with anti-static or other protective material. Wrap items to protect them from physical damage and from loss of data due to magnetic exposure. When a component needs to be fingerprinted, do not wrap it.

### Packaging

- a. Place the component into the labeled container.
- b. Package items to protect them from damage due to dropping or other physical impacts and from loss of data due to magnetic exposure:
  - Use large, plastic bubble-wrap or foam pads as packing material when original packing materials are not available.
  - **Do not** use Styrofoam as it creates static charges.
  - Protect internal storage from data loss (e.g., keep the CPU away from magnetic sources such as radios, heated seats, speakers).
- c. CPUs and hard drives should be packaged to protect fingerprints and transported upright, in a position that prevents movement while traveling.
- d. Monitors should be packaged and transported in a secure manner while protecting the screen and fingerprints.
- e. Close the container and completely seal the opening with evidence tape. Write your initials and identification number, and the time and date across the evidence tape seal.
- f. When transporting fragile computer components, label the outside of the transport container with handling instructions.
- g. When transporting a CPU or hard drive, attach a label indicating:
  - THIS END UP
  - FRAGILE
  - SENSITIVE ELECTRONIC EQUIPMENT
  - KEEP AWAY FROM MAGNETIC FIELDS
- h. Some data may be lost if battery power ceases while the related computer components are in storage. Inform the necessary personnel of computer components that rely on battery power



so that they can be maintained. When seizing laptops, tablet computers, and other battery powered devices, make every effort to locate and seize the power cables for the device.

- i. Store computer components in a secure area that is in a controlled climate away from magnetic sources, dust, and other contaminants.
- j. Computer components can be damaged when stored in areas where temperatures and humidity vary significantly.

### ***Procedure: Other Devices***

Other devices include copy and facsimile (fax) machines, printers, scanners, bar coding machines, answering machines, digital cameras, GPS devices, etc.

### **Equipment Needed**

Hand truck; cable tags and ties; rubber bands; non-magnetic flat-blade and Philips-type screwdrivers; hex and Star-type nut drivers; needle-nose and standard pliers; secure-bit drivers; small tweezers; wire cutters; anti-static bags, bubble-wrap and other packing materials; packing tape; paper bags and sturdy boxes; magnifying glass; evidence tape; flashlight; printer paper; CDs and 3½-inch diskettes; mobile phone; waterproof pen; labels; personal protective equipment.

- Electronic evidence is fragile and sometimes includes time-sensitive data of investigative value that is stored on or transmitted by electronic devices.
  - Handle electronic evidence as latent evidence because frequently it is not readily visible without the aid of other equipment and/or software.
  - Do not use destructive techniques, such as applying fingerprinting chemicals, before you examine the electronic evidence.
  - Federal and state laws regarding the interception of messages exist. State laws vary.
- a. Contact an electronic evidence collection expert as soon as the electronic device is discovered. Never move or alter the state of electronic hardware without first talking with an electronic evidence collection expert.
  - b. Fulfill the legal requirements necessary for seizure of the device by contacting the appropriate authorities to obtain legal advice and warrants, as needed.

- c. To determine legal requirements, follow departmental regulations while establishing whether there is probable cause to collect:
  - Hardware
  - Software
  - Data
- d. Identify whether a warrant is needed or there is an exception to the warrant requirement.
- e. Determine whether the device is stand-alone (i.e., not attached to a network) or attached to a network. Use these methods to locate a network:
  1. Interview people at the scene or informants.
  2. Look for multiple computers in the area.
  3. Determine whether a printer is in the area.
  4. Look for cables or connectors linking a computer, card scanner, fax machine, etc., to each other, to a phone jack or phone, to a printer, etc.
  5. If no cables are apparent and multiple devices are in the area, consider that a wireless network may be present. Work closely with an electronic evidence collection expert in this situation.
- f. Establish whether the evidence will be processed on- or off-site and make the necessary arrangements. Determine whether the device or data will be damaged or degraded if the device is moved. Do not use destructive techniques, such as applying fingerprinting chemicals, before you examine the electronic evidence.
- g. Determine whether an outside electronic evidence collection expert is needed and available to:
  1. Remove the device or provide instructions on how to remove it.
  2. Conduct the device and data investigation or provide instructions on how to do so.
- h. Maintain the state of the device as found until after documentation is complete and after being directed to do otherwise.
- i. Until there is an electronic evidence collection expert advising, do not disturb the network components. Whether the hardware was ON or OFF when found, leave it in that state. Never turn

off power to the hardware (such as a fax or answering machine) without:

1. Being advised to do so by an electronic evidence collection expert.
  2. Following shutdown procedures for that piece of hardware (locate and use documentation when needed).
- j. If it is determined that the device is running low on battery power, work with the expert to resolve this situation.

### Documentation

- a. Document the state of the device as it was found using photography, sketching, and note-taking.
- b. Photograph the screen, the back of the device, and connections to other equipment (e.g., camera with its lens cap and power cord nearby).
- c. Sketch a diagram of the placement of the device in the area and connections to other devices, equipment, and objects.
- d. Record information that supports the diagram and photographs, including the state of the device, any existing connections, and:
  - Equipment type
  - Equipment location
  - Equipment appearance/condition, including visible damage or other characteristics
  - Serial or other identifying numbers
- e. When preparing a device for packaging, label the cable with the port and evidence numbers before removing the cable from the port.
- f. Starting in the upper left corner of the device, assign each port a number (e.g., Port 1). Write the port number and evidence number on a label or piece of tape and adhere it to the cable.
- g. Do the same for the other end of the cable. If the other end of the cable is plugged into the wall, indicate this.
- h. After each cable is removed from a port, label the port with the assigned port number. Write the port number on a label or piece of tape. After the cable is removed from the port, place the label or tape over the port.

### Marking Evidence

**Evidence labeling:** Place a label on the device and any accompanying components such as battery chargers. Include your

initials and identification number, the date and time, evidence number, and evidence description.

**Evidence number:** Each piece of evidence must have a unique number. This number should correspond to the numbered placard next to the evidence.

**Evidence description:** The evidence description includes:

- Equipment type
- Equipment location
- Equipment appearance/condition, including visible damage or other characteristics
- Serial number

Label a container for the device. Include your initials and identification number, the date and time, evidence number, and evidence description.

When practical, wrap the device with anti-static or other protective material. Wrap items to protect them from physical damage and from loss of data due to magnetic exposure.

When a device needs to be fingerprinted, do not wrap it.

### Packaging

- a. Place the device into the labeled container.
- b. Package items to protect them from damage due to dropping or other physical impacts and from loss of data due to magnetic exposure:
  - Use large, plastic bubble-wrap or foam pads as packing material when original packing materials are not available.
  - **Do not** use Styrofoam as it creates static charges.
  - Protect internal storage from data loss (e.g., keep the CPU away from magnetic sources such as radios, heated seats, speakers).
- c. CPUs and hard drives should be packaged to protect fingerprints and transported upright, in a position that prevents movement while traveling.
- d. Monitors should be packaged and transported in a secure manner while protecting the screen and fingerprints.
- e. After placing the component into a container, close the container and completely seal the opening with evidence tape. Write your initials and identification number and the time and date across the evidence tape seal.

- f. When transporting fragile electronic devices, label the outside of the transport container with handling instructions. Attach a label indicating:
  - THIS END UP
  - FRAGILE
  - SENSITIVE ELECTRONIC EQUIPMENT
  - KEEP AWAY FROM MAGNETIC FIELDS
- g. Some data may be lost if battery power ceases while the related device is in storage. Inform the necessary personnel when the device relies on battery power so that they can maintain it.
- h. Store the device in a secure area, in a controlled climate away from magnetic sources, dust, and other contaminants.
- i. Electronic devices, such as cameras, copy, fax and answering machines, can be damaged when stored in areas where temperatures and humidity vary significantly.



### ***Procedure: Wireless Phones and Pagers<sup>10,11</sup>***

Wireless phones and pagers, in this context, include cellular phones; numeric, alphanumeric and two-way pagers; Personal Digital Assistants (PDAs); radio scanners; etc.

### **Equipment Needed**

***Faraday Bags***, Anti-static bags, bubble-wrap and other packing materials; packing tape; paper bags and boxes; evidence tape; waterproof pen; labels; personal protective equipment.

- Phones, pagers, and PDAs are capable of receiving and storing information, such as text and voice messages, phone lists, memorandums, and caller identification and appointment information.
- Radio scanners can be powered by a cigarette lighter in a vehicle and by other common power sources. The scanners can be used to monitor phone conversations, detect radar, and capture personal Internet or network information from afar.
- GPS devices may store information on previous locations and searches conducted by the user.
- Federal and state laws regarding the privacy of pagers and intercepting messages exist. State laws vary.

<sup>10</sup> See also *Special Considerations When Dealing with Cellular Phones*, <https://www.swgde.org/documents/Current%20Documents>. Accessed February 29, 2012

<sup>11</sup> See also *Best Practices for Mobile Phone Examinations*, <https://www.swgde.org/documents/Current%20Documents>. Accessed February 29, 2012.

- a. Fulfill the legal requirements necessary for seizure of the wireless phone or pager by contacting the appropriate authorities to obtain legal advice and warrants, as needed.
- b. To determine legal requirements, follow departmental regulations while establishing whether there is probable cause to collect:
  - Hardware
  - Software
  - Data
- c. Identify whether a warrant is needed or there is an exception to the warrant requirement.
- d. Maintain the state of the wireless phone or pager as found until after documentation is complete and after being directed to do otherwise.
- e. Whether the device was ON or OFF when found, leave it in that state until advised by an electronic evidence collection expert. Never turn off a mobile phone or pager without:
  - Being advised to do so by an electronic evidence collection expert.
  - Following shutdown procedures (locate and use documentation when needed).
- f. If it is determined that the wireless phone or pager is running low on battery power, work with the expert to resolve this situation.

### Documentation

- a. Document the state of the wireless phone or pager as it was found using photography, sketching, and note-taking.
- b. Photograph the screen, the back of the phone or pager, and other related equipment (e.g., battery charger regardless of whether phone is connected to the charger).
- c. Sketch a diagram of the placement of the device in the area and relative to other devices, equipment, and objects.
- d. Record information that supports the diagram and photographs, including the state of the wireless phone or pager, existing connections, and:
  - Equipment type
  - Equipment location

- Equipment appearance/condition, including visible damage or other characteristics
  - Serial or other identifying numbers
- e. Establish whether the evidence will be processed on- or off-site and make the necessary arrangements. Determine whether the device or data will be damaged or degraded if it is moved. Do not use destructive techniques, such as applying fingerprinting chemicals, before you examine the wireless phone or pager evidence.
- f. Determine whether an outside electronic evidence collection expert is needed and available to:
- Examine the wireless phone or pager and related data.
  - Provide instructions on how to do so.

### Marking Evidence

**Evidence packaging:** When preparing a wireless phone or pager for packaging, label a container with your initials and identification number, the date and time, evidence number, and evidence description.

Whenever possible, use the original packing materials, including the fitted padding. Otherwise, use sturdy cardboard containers.

Retrieve and store power cables and adapters with recovered phones and pagers. It may be necessary to use the power cable or adapter for a device while the device is stored.

**Evidence number:** Each piece of evidence must have a unique number. This number should correspond to the numbered placard next to the evidence.

**Evidence description:** The evidence description includes:

- Equipment type
- Equipment location
- Equipment appearance/condition, including visible damage or other characteristics
- Serial or other identifying number

When practical, wrap the wireless phone or pager with anti-static or other protective material. Wrap items to protect them from physical damage and from loss of data due to magnetic exposure.

When a wireless phone or pager needs to be fingerprinted, do not wrap it.



## Packaging

- a. Place the wireless phone or pager into the labeled container. Wireless devices should be packaged in a Faraday bag or in a manner that prevents them from receiving incoming transmissions. Many devices have the ability to receive commands to delete all data or be remotely locked. One method of preventing incoming signals, if a Faraday bag is not available, is to place the device into “Airplane mode”.
- b. Package items to protect them from damage due to dropping or other physical impacts and from loss of data due to magnetic exposure:
  - Use large, plastic bubble-wrap or foam pads as packing material when original packing materials are not available.
  - **Do not** use Styrofoam as it creates static charges.
  - Protect internal storage from data loss (e.g., keep away from magnetic sources such as radios, heated seats, speakers).
- c. Label the outside of the container with handling instructions.
- d. When transporting electronic evidence, attach a label indicating:
  - FRAGILE
  - SENSITIVE ELECTRONIC EQUIPMENT
  - KEEP AWAY FROM MAGNETIC FIELDS
- e. Some data may be lost if battery power ceases while the wireless phone or pager is in storage. Inform the necessary personnel of wireless phones or pagers that rely on battery power so that they can be maintained.
- f. Store the wireless phone or pager in a secure area, in a controlled climate away from magnetic sources, dust, and other contaminants.
- g. Electronic devices can be damaged when stored in areas where temperatures and humidity vary significantly.



## Fingerprints

### *Processing Material for Fingerprints*

The processing of items for fingerprints is done in accordance with the goals of the investigation. The prints should be obtained using accepted practices for that type of item, taking into consideration the weather conditions, substrate, matrix and nature of the case. The following procedures are addressed in this section:

- Procedure: Latent Fingerprints

Courtesy Ron Smith  
& Associates

- Procedure: Patent (Visible) Fingerprints
- Procedure: Chemical Processing

### ***Physical Processes: Latent Fingerprints***

#### **Equipment Needed**

Fingerprinting kit (fingerprint powder, soft bristled brush, single-use brushes if chemical or biological contamination is possible, lifting tape, 8½" x 11" card stock papers); contact paper; envelopes; waterproof pen; evidence tape; ruler; identification labels; protective gloves; face protection.

- Prints on evidence are fragile. The slightest amount of handling can degrade a print.
  - Whenever possible, collect the object on which you find prints.
  - Photograph the powdered print before collecting it.
  - Always use clean gloves when handling evidence.
  - Remember: Your prints and DNA may be transmitted by gloves when you touch anything, such as when you scratch your nose.
- a. Identify the object that needs to be dusted.
    - Smooth surfaces yield the best latent prints.
    - When looking for latent prints, examine windows, mirrors, glasses, door handles, doors, etc.
  - b. Position the print powder, brush, and lifting tape within reach of the object.
    - Use a powder color that contrasts with the background of the item from which the print is being collected.
    - The color of the backing material must contrast with the color of the print powder used.
  - c. Gently brush the powder onto the object. When available, follow manufacturer's development process instructions.
    1. Pour a small amount of powder on a clean piece of paper or jar lid.
    2. Lightly dip the brush into the powder.
    3. Tap the brush lightly to cause excess powder to fall off of the brush onto the paper.
    4. Carefully and gently brush the object being printed using curved strokes that follow the natural lines of the print.

*Note:* Don't ever blow on the surface since it can contaminate the surface with DNA.

### Documentation

Endeavor to photograph the developed print. When photographing the developed print:

- Ensure that each photograph shows the scale and identification label.
- Always shoot location photographs as well as one-to-one/close-up photographs.

### Evidence Marking

**Evidence packaging:** Label a lift card for the print with your initials and identification number, the date and time, evidence number, and evidence description.

Record the information on the back of the card holding the lifted print.

**Evidence number:** Each piece of evidence must have a unique number. This number should correspond to the placard next to the evidence.

**Evidence description:** The evidence description includes:

- Type of print being collected
- Location of the print
- Orientation of the print to north or to a prominent nearby object; e.g., "Fingerprints found on telephone receiver."
- A brief diagram of the location of the print on an object, depicted with an "x".

### Lifting Fingerprints

- a. Remove a piece of lifting tape.
- b. If a pre-made tape lift is being used, open the tape lift and remove the protective seal over the sticky part of the tape.
- c. If contact paper is being used, remove the protective backing that covers the adhesive side of the paper.
- d. Press the sticky side of the lifting tape to the developed print. Use firm but gentle pressure taking care not to smear the print.
- e. Place the sticky side of the lifting tape onto the card stock. Protect the print by pressing the lifting tape to the card stock while taking care not to smear the print.

### Packaging

- a. Place the print lift in a container.
- b. Multiple print lifts can be placed in the same container.
- c. Submit **all** print lifts to the laboratory. Do not attempt to determine which lifts are suitable for comparison purposes.
- d. Close the container and seal the entire opening with evidence tape. Write your initials and identification number, and the date and time across the evidence tape seal.
- e. If printing a surface that may contaminate the fingerprint brush or powder with physiological fluids or controlled substances, do not use them on subsequent items until they have been decontaminated.
- f. If possible, collect the item on which the print was found.
- g. If the print is still moist, allow it to dry before collecting it.
- h. When packaging an item with a developed print on it, be sure the transport container is made of paper and large enough to hold the item without damaging the print.
- i. Place the item with the print, print side up, into the container while protecting the print from being touched. Secure the item so that the print will not move or be disturbed during transport.
- j. Seal the container with the evidence tape. Label the evidence tape.

### ***Procedure: Patent (Visible) Fingerprints***

#### Equipment Needed

Photography kit; flashlight and other available light sources; containers; waterproof pen; evidence tape; ruler; identification labels; protective gloves; face protection

- Prints on evidence are fragile. The smallest amount of handling can degrade a print.
- Always photograph the print before collecting it.
- Always use clean gloves when handling evidence.
- Your prints may be transmitted through your gloves when you touch anything, such as when you scratch your nose.

#### Documentation

Photograph the visible print. When photographing the print:

- Ensure that each photograph shows the scale and identification label.

- Always shoot location photographs as well as one-to-one/close-up photographs.

### Collection

- If possible, collect the item containing the visible print.
- If the print is still moist, allow it to dry before collecting it.

### Packaging

- Select a suitable container to transport the print. Make sure it is made of paper and is large enough to hold the item without damaging the print.
- Place the item with the print on it, print side up, into the transport container while protecting the print from being touched.
- Secure the item so that the print will not move or be disturbed during transport.
- Seal the container with the evidence. Label the evidence tape.

### *Procedure: Chemical Processing*

- Chemical processing is best performed in a laboratory or controlled environment. Chemical processing involves safety considerations since the chemicals used may constitute a hazard.
- Chemical processing should only be performed by someone trained in the use of the process in the field.

Some of the chemical processes available are listed in the table below:

Chemical Reagent	Suitable Surfaces
<b>Ninhydrin</b> (Caution: If ninhydrin is used at the crime scene, proper safety precautions must be taken. Solvents used in the preparation of ninhydrin can be flammable or deplete oxygen.)	Porous surfaces: <ul style="list-style-type: none"> <li>• Paper</li> <li>• Wood</li> <li>• Wall board</li> </ul>
<b>Cyanoacrylate Ester or Super Glue</b>	Non-porous surfaces: <ul style="list-style-type: none"> <li>• Glass</li> <li>• Metal</li> <li>• Semi-porous surfaces (e.g., glossy or coated)</li> </ul>
<b>Small particle reagent</b>	<ul style="list-style-type: none"> <li>• Wet surfaces</li> </ul>

<b>Crystal Violet</b>	<ul style="list-style-type: none"> <li>• Sticky side of adhesive tapes</li> </ul>
<b>Sudan Black</b>	<ul style="list-style-type: none"> <li>• Plastic baggies</li> <li>• Coated drinking cups and plates</li> <li>• Food stuff–contaminated non- and semi-porous items</li> <li>• Cyanoacrylate ester–processed items</li> </ul>
<b>Amido Black, Leuco-Crystal Violet, DAB, etc.</b>	<ul style="list-style-type: none"> <li>• Blood-contaminated impressions</li> </ul>

Latent prints can also be enhanced by use of a *forensic light source* in combination with the following processing chemicals and powders:

- DFO
- Indanedione
- Rodamine 6G, RAM, Basic Yellow, etc.
- Redwop, Greenwop



## Comparison/Elimination Prints

### *Procedure: Inked Prints*

#### Equipment Needed

Fingerprinting kit (fingerprint ink pads, fingerprint cards, fingerprint card holders); ink remover towels or waterless hand cleaner; envelopes; waterproof pen; identification labels; protective gloves

- Coordinate with the Medical Examiner or Coroner before attempting to collect prints from a deceased person. Protect a deceased person's hands and feet by covering them with paper bags that are secured at the victim's wrist and ankle. Never use plastic bags to protect these areas of a body.
- Elimination prints can be collected after evidence collection has occurred.
- The preferred method for collecting comparison/elimination prints is using ink.
- Finger, palm, hand, toe, heel, feet, and *major case prints* can be inked and rolled.
- Always use clean gloves when handling evidence.

- a. Before collecting prints, ensure that the hands are photographed to document any trace material or physiological fluid which may be present, and collect the material before proceeding.
- b. Set up the location where prints will be taken, preferably on a flat surface. Ensure that fingerprint supplies are easily accessible and ready for use.
- c. Instruct the person to clean their hands before rolling the prints if applicable.
- d. Complete as much of the information requested on the print card as possible. Critical information includes your name and identification number, the name of the fingerprinted person, the date and time, and which hand was printed.
- e. Insert the print card into a card holder.
- f. Position the person being printed so that the hands are easily accessible to you without your firearm side being exposed, if you are wearing a firearm.
- g. Just before rolling prints, put on clean gloves to ensure that you have eliminated the possibility of transferring your prints to the card.
- h. The person being printed should stand facing the print card. You can stand, being sure to safeguard your firearm if you are wearing one, to the side of the hand being printed or in front of the person.
- i. Hold the person's thumb tip and wrist gently, and press the thumb onto the ink strip. Roll the thumb on the ink from the edge of the nail on one side to the edge of the nail on the other side.
- j. Be sure to ink the tip of the thumb (or finger) well so that the developed print is as clear and complete as possible.
- k. Gently and with steady force, press the inked thumb to the card and roll it from the edge of the nail on one side to the edge of the nail on the other side.
- l. Repeat the inking and rolling process for all fingers on one hand, starting with the index finger. Print the fingers in this order: index, middle, ring, and little.
- m. When a print is smudged or otherwise defective on the card, take another print on a new card for that finger only. Label the card so that it clearly corresponds with the card containing the smudged print. Never discard a print card; do not cover the print with a fingerprint tab designed for this purpose.



- n. When print impressions are not clear due to a skin condition or other circumstance, write “Best print possible due to (reason)” in the space nearest the print on the card.
- o. When a finger is injured or missing, note the condition in the space for that finger.
- p. When necessary, obtain a new card for the prints from the other hand. When using a ten print card, use the space provided for the other hand.
- q. Package to protect the completed card.

***Procedure: Flexible Lifter***

**Equipment Needed**

Fingerprinting kit (fingerprint powder, soft bristled brush); flexible plastic lifters (e.g., Handiprint©, Kinderprint©); fingertip moistener; waterless hand cleaner; envelopes; waterproof pen; protective gloves.

- Coordinate with the Medical Examiner or Coroner before attempting to collect prints.
  - Protect a dead victim’s hands and feet by covering them with paper bags that are secured at the victim’s wrist and ankle.
  - Elimination prints can be collected after evidence collection has occurred.
  - Finger, palm, hand, toe, heel, and feet prints, and major case prints can also be developed using this method.
  - Always use clean gloves when handling evidence.
- a. Prepare to take the prints by setting up the location where prints will be taken and instructing the person to clean their hands if they are very soiled.
  - b. Before collecting prints, ensure that the hands are photographed to document any trace material or physiological fluid which may be present, and collect the material before proceeding.
  - c. Complete as much of the information requested on the print card as possible. Critical information includes your name and identification number, the name of the fingerprinted person, the date and time, and which hand was printed.
  - d. Avoid touching the lifter in the area where the person’s prints will be developed.
  - e. Cut a sheet of flexible plastic lifter into 1½" x 8" strips to record fingers.

- f. Rub a small amount of fingertip moistener onto the subject's fingers. Any excess may be wiped off with a paper towel.
- g. Lightly dust palm side of hand with black fingerprint powder.
- h. Separate release paper from flexible plastic lifter.
- i. Spread fingers and press hand on adhesive side of lifter.
- j. Lift hand. Press the lifter along the length of each finger, and around the sides of the fingertips.
- k. Press around thumb as much as possible.
- l. Larger pieces of lifter can be used to capture palm detail.
- m. Prepare a backing material, such as clear acetate, and cover the adhesive side of the lifter with the acetate. Write identifying information on the back of the lifter.
- n. Trim and add to a tenprint fingerprint card, if applicable.
- o. When print impressions are not clear due to a skin condition or other circumstance, write "Best print possible due to (reason)." in the space nearest the print on the card.
- p. When a thumb or finger is injured or missing, note the condition of the thumb or finger in the space for the print.
- q. Repeat the rolling and dusting process to collect the thumb and fingerprints from the person's other hand.
- r. Place the print cards in the container.



### Tool Mark Evidence

A tool mark is any impression, scratch, gouge, cut, or abrasion made when a tool is brought into contact with an item, leaving an impression of the tool. In some cases, tool mark identification may link a person to the tool used in the commission of a crime.

#### Equipment Needed

Casting kit (e.g., Duplicast™, Mikrosil™, silicone-type sealant); mixing pad; stirring stick; flashlight and other available light sources; paper envelopes and boxes; waterproof pen; measuring tape/ruler; identification labels; protective gloves; face protection.

- Photograph the impression before casting it.
- When making a cast, be prepared to act quickly and methodically. Time is often a critical factor in successfully making a cast.
- Always use clean gloves when handling evidence.

## Documentation

Photograph the impression. When photographing the object:

- Include a scale and an identification label.
- Take one or more location photographs that show the object where it was found.
- Show the relationship of the object to other evidence in the photograph.

## Evidence Marking

**Evidence labeling:** Label a container for the object with your initials and identification number, the date and time, evidence number, location, and evidence description.

**Evidence number:** Each piece of evidence must have a unique number. This number should correspond to the placard next to the evidence.

**Evidence description:** The evidence description includes:

- Type of item being cast
- Location of the item being cast
- Orientation of the item being cast to north, to a feature of the object with the impression on it, or to a nearby object.

## Casting the Evidence

- a. Label the container just before collecting an object, and seal the container immediately after collection.
- b. Clean out loose material from the impression, when possible, without disturbing the impression. Never discard a cast, regardless of condition when removed from the impression. Be sure to save and submit all casts to the laboratory.

## Packaging

- a. Close the container and seal the entire opening with evidence tape. Write your initials and identification number, and the date and time across the evidence tape seal.
- b. Make sure that the container is also labeled with a description of the item cast, your initials and identification number, the date and time, location and, when possible, the evidence number.
- c. If the item with the tool mark is collected, it should be packaged to prevent any additional marks, impressions or other damage.  
**Never place the suspected item into the impression.**

**Summary:** Evidence at crime scenes that is in the process of documentation, collection, preservation, or packaging should be

handled with attention to scene integrity and protection from contamination or deleterious change. During the processing of the scene, and following documentation, evidence should be appropriately packaged, labeled, and maintained in a secure, temporary manner until final packaging and submission to a secured evidence storage facility or the crime laboratory.

## D.

# Completing and Recording the Crime Scene Investigation

## 1. Establish Crime Scene Debriefing Team



**Principle:** The crime scene debriefing enables law enforcement personnel and other responders to share information regarding particular scene findings prior to releasing the scene. It provides an opportunity for input regarding follow-up investigation, special requests for assistance, and the establishment of post-scene responsibilities.

**Policy:** Law enforcement personnel and other responders shall participate in or initiate a crime scene debriefing to ensure the crime scene investigation is complete and to verify post-scene responsibilities.

**Procedure:** The investigator(s) in charge of the crime scene should establish a crime scene debriefing team. When participating in a scene debriefing, law enforcement personnel and other responders should:

- a. Establish a crime scene debriefing team, which includes the investigator(s) in charge of the crime scene, other investigators and **evidence collection** personnel (e.g., photographers, evidence technicians, latent print personnel, specialized personnel, and initial **responding officer(s)** if still present).
- b. Determine what evidence was collected.
- c. Discuss preliminary scene findings with **team members**.
- d. Discuss potential technical forensic testing and the sequence of tests to be performed.
- e. Initiate any action(s) identified in discussion that are required to complete the crime scene investigation.
- f. Brief person(s) in charge upon completion of assigned crime scene tasks.
- g. Establish post-scene responsibilities for law enforcement personnel and other responders.

**Summary:** The crime scene debriefing is the best opportunity for law enforcement personnel and other responders to ensure that the crime scene investigation is complete.

## 2. Perform Final Survey of the Crime Scene

**Principle:** Final survey of the crime scene ensures that evidence has been collected and the scene has been processed prior to release. In addition, a systematic review of the scene ensures that evidence, equipment, or materials generated by the investigation are not inadvertently left behind and any dangerous materials or conditions have been reported and addressed.

**Policy:** The investigator(s) in charge shall direct a *walk-through* at the conclusion of the scene investigation and ensure that the scene investigation is complete.

**Procedure:** The investigator(s) in charge should ensure that:

- a. Each area identified as part of the crime scene is visually inspected.
- b. All evidence collected at the scene is accounted for.
- c. All equipment and materials generated by the investigation are removed.
- d. Any dangerous materials or conditions are reported and addressed.
- e. The crime scene is released in accordance with jurisdictional requirements.
- f. Consider taking photographs depicting the condition of the scene at the time.

**Summary:** Conducting a scene walk-through ensures that all evidence has been collected, that materials are not inadvertently left behind, and that any dangerous materials or conditions have been reported and addressed.

## 3. Documentation of the Crime Scene

**Principle:** Compiling reports and other documentation pertaining to the crime scene investigation into a “case file” provides a record of

the actions taken and evidence collected at the scene. This documentation allows for independent review of the work conducted.

**Policy:** The investigator(s) in charge shall ensure that reports and other documentation pertaining to the crime scene investigation are compiled.

**Procedure:** The investigator(s) in charge should obtain the following for the crime scene case file:

- a. Initial responding officer(s) documentation.
- b. Emergency medical personnel documents.
- c. Entry/exit documentation.
- d. Photographs/videos.
- e. Crime scene sketches/diagrams.
- f. Evidence documentation.
- g. Other responders' documentation.
- h. Record of consent form or search warrant.
- i. Reports such as forensic/technical reports, when they become available.

**Note:** The above list is limited to crime scene documentation. This should not be considered a comprehensive list of the documents involved in an investigative case file.

**Summary:** This procedure will ensure that reports and other documentation pertaining to the crime scene investigation are compiled into a case file by the investigator(s) in charge of the crime scene and allow for independent review of the work conducted.

## 4. Acknowledge Specialized Crime Scene Circumstances

**Principle:** While all crime scene investigations pose their individual complexities, some situations may involve atypical crime scene locations or requirements for which Law enforcement personnel and other responders should be aware.

**Policy:** Law enforcement personnel and other responders shall vigilantly prepare for crime scene investigations under specialized crime scene circumstances.



**Procedure:** Crime scene investigators should adjust their approach to an investigation to warrant specific needs of the investigation which includes:

- Crime Scenes in correctional and custodial facilities
- Crime scenes in which the safety of the crime scene investigators must be considered in the approach to the time spent at the scene

### Crime Scene Investigation in Correctional and Custodial Facilities

Investigations conducted in correctional and custodial facilities require significant awareness on the part of the crime scene investigator. Using the appropriate search methodology is key to a thorough investigation. Additional guidance is provided if the focus of the search is a place of confinement, e.g., a cell.

- a. Use a search method appropriate for the size of the area of confinement.
- b. Consider that evidence could exist or be placed at higher levels than is typical in a crime scene. Make sure you look up.
- c. Consider that some evidence may be deliberately covered up. Move layers of material, looking for potential evidence underneath.
- d. Move material aside and search. In cells, this includes:
  - bedding material
  - bedding frames
  - lamps
  - air grates
  - plumbing and *chases*
  - cell bar attachments, such as to walls
  - trash receptacles
- e. Carefully examine materials encountered. Even an item such as a pen can be modified to be a weapon. Assume nothing is as it first appears.
- f. Have custodial staff advise if anything appears different or out of place for their facility.

### Time-Limited Crime Scene Investigation

In some instances, deteriorating security or environmental conditions limit the amount of time available for the investigation of the crime scene. While these time limits will not allow for a thorough crime scene investigation to be conducted, the following procedure will maximize the use of the limited time onsite.

In such circumstances, preparation prior to staging or entry into the crime scene area is paramount. This could include a site survey (e.g., in-person, photographic, photogrammetric or videographic) prior to the team's arrival at the scene or conducting extensive interviews of any witnesses from the area.

Elements of this preparation and execution are designed to:

- a. Determine the time available to remain at the crime scene based upon best knowledge of time-limiting factors.
- b. Determine the most critical objective of being on the site of the investigation; e.g., removal of a deceased body, identification of suspect, collection of explosive residue, etc.
- c. Determine the equipment needed to fulfill the objective. Pre-package from established crime scene collection kits a ready-kit for this specific event.
- d. Determine any specialized personnel that may be needed on-scene for this investigation.
- e. Develop a documentation and collection plan to include:
  - Type and nature of documentation expected
  - Priority of evidence collection
  - Responsibility for onsite collection
  - Responsibility for evidence custody

**Summary:** Crime scene investigation in specialized circumstances requires the application of techniques that have been adapted for unusual conditions.

## E.

# Crime Scene Equipment

## 1. Initial Responding Officer(s)

### Essential\*

- Consent/search forms.
- Crime scene barricade tape.
- First-aid kit.
- Flares.
- Flashlight and extra batteries.
- Paper bags.
- Personal protective equipment (PPE)

\* These items should be in police vehicles or readily available to initial responding officer(s).

### Optional

- Audiotape recorder
- Camera with flash and extra film, if not digital camera
- Chalk
- Directional marker/compass
- Disinfectant (such as a 10% bleach solution)
- Maps
- Plastic bags
- Pocket knife
- Reflective vest
- Tape measure
- Tarps to protect evidence from the weather
- Traffic cones
- Waterless hand wash (towelette with germicide)
- Wireless phone

## 2. Crime Scene Investigator/Evidence Technician

### Essential\*

- Bindle paper
- Biohazard bags
- Body fluid collection kit
- Camera with flash and tripod; extra film, if not digital; extra flash memory cards, if digital
- Casting materials
- Consent/search forms
- Crime scene barricade tape
- Cutting instruments (knives, box cutter, scalpel, scissors, etc.)
- Directional marker/compass
- Disinfectant (such as a 10% bleach solution)
- Evidence collection containers including rigid containers for firearms and ammunition boxes, pie boxes with sheet cotton for document recovery; manila folders
- Evidence identifiers (numbers, placards)\_
- Evidence seals/tape
- First-aid kit
- Flashlight and extra batteries
- High-intensity lights
- Latent print kit
- Magnifying glass
- Measuring devices
- Permanent markers
- Personal protective equipment (PPE)
- Photographic scale (ruler)
- Presumptive blood test supplies
- Sketch paper
- Tool kit
- Tweezers/forceps
- Window screen fabric in rolls or sheets

\* These items should be in vehicles or readily available to Crime Scene Investigator/Evidence Technician.

## Optional

- Audiotape recorder
- Bloodstain pattern examination kit
- Business cards
- Chalk
- Chemical enhancement supplies
- Compass
- Entomology (insect) collection kit
- Extension cords
- Flares
- Forensic light source (alternate light source, UV lamp/laser, goggles)
- Generator
- Gunshot residue kit
- Laser trajectory kit
- Maps
- Marking paint/snow wax
- Metal detector
- Mirror
- Phone listing (important numbers)
- Privacy screens
- Protrusion rod set
- Reflective vest
- Refrigeration or cooling unit
- Respirators with filters
- Roll of string.
- Rubber bands.
- Sexual assault evidence collection kit (victim and suspect)
- Shoe print lifting equipment
- Templates (scene and human)
- Thermometer
- Traffic cones
- Trajectory rods
- Video recorder
- Wireless phone

## 3. Evidence Collection Kits (Examples)

### Blood Collection

- Bindle
- Coin envelopes
- Disposable scalpels
- Distilled water or single use sterile water droppers
- Evidence identifiers
- Drying box
- Latex gloves
- Photographic ruler (ABFO scales)
- Presumptive chemicals
- Swabs

### Fingerprint

- Adhesive and gelatin lifting materials
- Brushes
- Chemical enhancement supplies
- Cyanoacrylate (super glue) wand/ packets
- Fingerprint ink pads, cards and card holders for exemplar collection
- Flashlight
- Forensic light source
- Lift cards, including 8 1/2" x 11" card stock
- Lift tape
- Measurement scales
- Powders

### Bloodstain Pattern Documentation

- ABFO scales
- Calculator
- Laser pointer
- Permanent markers
- Protractor
- String
- Tape

## Electronic and Digital Evidence Recovery

- Anti-static bags
- Bubble-wrap and other packing materials
- Cable tags and ties
- CDs and 3½-inch diskettes
- Faraday Bags
- Hand truck
- Nut drivers, hex and star-type
- Pliers: needle-nose and standard
- Rubber bands
- Magnifying glass
- Printer paper
- Secure-bit drivers
- Screwdrivers, non-magnetic flat-blade and Philips-type
- Tweezers, small non-magnetic
- Wire cutters

## Excavation and Evidence Recovery

- Cones/markers
- Evidence identifiers
- Hand tools (hammer, chisel/screwdriver, forceps, hand saw, box cutter, drywall saw, etc.)
- Metal detectors
- Paintbrushes
- Shovels/trowels
- Sifting screens
- String
- Weights
- Wooden/metal stakes

## Impressions – footwear, tire tracks and tool mark

- Bowls/mixing containers
- Boxes
- Casting Kit (e.g. Duplicast®, Mikrosil® or polyvinylsiloxane (PVS) materials, silicone-type sealant)
- Dental stone
- Evidence identifiers



- Material for forms
- Measurement scales
- Permanent markers
- Snow print wax
- Stirring sticks
- Water

## Pattern Print Lifter

- Chemical enhancement supplies
- Electrostatic dust lifter
- Gel lifter
- Wide format lift tape

## Trace Evidence Collection

- Acetate sheet protectors or clear secondary liners
- Bindle paper or weigh paper for bindles
- Butcher paper
- Clear packing/sealing tape 2 1/2- to 4 inches wide
- Cotton-tipped swab
- Flashlight (oblique lighting)
- Forceps/tweezers (disposable or clean smooth tipped)
- Glass jars, bottles, vials with air-tight, screw-on lids
- Metal friction lid cans with fitting lids
- Slides and slide mailers
- Trace evidence vacuum with disposable collection filters
- Transfer pipettes (glass or plastic)

# Appendices

Appendix A	Glossary
------------	----------

Appendix B	Reference List
------------	----------------

Appendix C	Diagrams
------------	----------

## Appendix A. Glossary

The definitions below apply to terms as used in this document.

**ABFO scales:** (American Board of Forensic Odontology scales). An L-shaped piece of plastic used in photography that is marked with circles, black and white bars, and 18-percent gray bars to assist in distortion compensation and provide exposure determination. For measurement, the plastic piece is marked in millimeters.

**Alternate light source (ALS):** Equipment used to produce visible and invisible light at various wavelengths to enhance or visualize potential items of evidence (fluids, fingerprints, clothing fibers, etc.).

**Argon ion laser:** The first generation of lasers used for detection of latent fingerprints. Expensive and non-portable, they have been supplanted by the introduction of solid-state and semi-conductor lasers.

**Bindle paper:** Clean paper that is folded to contain trace evidence, sometimes included as part of the packaging for collecting trace evidence.

**Biohazard bag:** A container for materials that have been exposed to blood or other biological fluids.

**Biological fluids:** Fluids that have human or animal origin, most commonly encountered at crime scenes (e.g., blood, mucus, perspiration, saliva, semen, vaginal fluid, urine).

**Biological weapon:** Biological agents used to threaten human life (e.g., anthrax, smallpox, or any infectious disease).

**Bloodborne pathogen:** Infectious, disease-causing microorganisms that may be found or transported in biological fluids.

**Boundaries:** The perimeter or border surrounding potential physical evidence related to the crime.

**Case file:** The collection of documents comprising information concerning a particular investigation. (This collection may be kept in case jackets, file folders, ring binders, boxes, file drawers, file cabinets, or rooms. Sub-files are often used within case files to segregate and group interviews, media coverage, laboratory requests and reports, evidence documentation, photographs, videotapes, audiotapes, and other documents.)

**Case identifiers:** The alphabetic and/or numeric characters assigned to identify a particular case.

**Chase:** A space in a wall or floor for pipes or ducts.

**Chain of custody:** A process used to maintain and document the chronological history of the evidence. (Documents should include name or initials of the individual collecting the evidence, each person or entity subsequently having custody of it, dates the items were collected or transferred, agency and case number, victim's or suspect's name, and a brief description of the item.)

**Chemical enhancement:** The use of chemicals that react with specific types of evidence (e.g., blood, semen, lead, fingerprints) in order to aid in the detection and/or documentation of evidence that may be difficult to see.

**Chemical threat:** Compounds that may pose bodily harm if touched, ingested, inhaled, or ignited. These compounds may be encountered at a clandestine laboratory, or through a homemade bomb or tankard leakage (e.g., ether, alcohol, nitroglycerin, ammonium sulfate, red phosphorus, cleaning supplies, gasoline, or unlabeled chemicals).

**Clean/sanitize:** The process of removing biological and/or chemical contaminants from tools and/or equipment (e.g., using a mixture of 10-percent household bleach and water).

**Collect/collection:** The process of detecting, documenting, or retaining physical evidence.

**Comparison samples:** A generic term used to describe physical material/ evidence discovered at crime scenes that may be compared with samples from persons, tools, and physical locations. Comparison samples may be from either an unknown/questioned or a known source.

Samples whose source is unknown/questioned are of three basic types:

1. Recovered crime scene samples whose source is in question (e.g., evidence left by suspects, victims).
2. Questioned evidence that may have been transferred to an offender during the commission of the crime and taken away by him or her. Such questioned evidence can be compared with evidence of a known source and can thereby be associated/linked to a person/ vehicle/tool of a crime.
3. Evidence of an unknown/questioned source recovered from several crime scenes may also be used to associate multiple offenses that were committed by the same person and/or with the same tool or weapon.

Samples whose source is known are of three basic types:

1. A standard/reference sample is material of a verifiable/documented source which, when compared with evidence of an unknown source, shows an association or linkage between an offender, crime scene, and/or victim (e.g., a carpet cutting taken from a location suspected as the point of transfer for comparison with the fibers recovered from the suspect's shoes, a sample of paint removed from a suspect's vehicle to be compared with paint found on a victim's vehicle following an accident, or a sample of the suspect's and/or victim's blood submitted for comparison with a bloodstained shirt recovered as evidence).
2. A control/blank sample is material of a known source that presumably was uncontaminated during the commission of the crime (e.g., a sample to be used in laboratory testing to ensure that the surface on which the sample is deposited does not interfere with testing. For example, when a bloodstain is collected from a carpet, a segment of unstained carpet must be collected for use as a blank or elimination sample).
3. An elimination sample is one of known source taken from a person who had lawful access to the scene (e.g., fingerprints from occupants, tire tread impressions from police vehicles, footwear impressions from emergency medical personnel) to be used for comparison with evidence of the same type.

**Contamination:** The unwanted transfer of material from another source to a piece of physical evidence.

**Control/blank sample:** See comparison samples.

**Cross-contamination:** The unwanted transfer of material between two or more sources of physical evidence.

**Documentation:** Written notes, audio/videotapes, printed forms, sketches and/or photographs that form a detailed record of the scene, evidence recovered, and actions taken during the search of the crime scene.

**Drying box:** A box intended to quickly dry multiple swabs with the aid of a fan blowing air through a chamber in which multiple swabs can be held apart from one another.

**Dying declaration:** Statements made by a person who believes he or she is about to die, concerning the cause or circumstance surrounding his or her impending death.

**Electrostatic dust lifter:** A device that operates by charging a plastic film, placed over the dust print, which creates electrostatic adhesions and draws the film onto the surface bearing the print. The dust

particles are attracted to the film because of this charge and adhere to it.

**Elimination sample:** See comparison samples.

**Evidence identifiers:** Tape, labels, containers, and string tags used to identify the evidence, the person collecting the evidence, the date the evidence was gathered, basic criminal offense information, and a brief description of the pertinent evidence.

**Exemplars:** A known sample of evidence created at the request of an investigator used for comparison to an unknown sample.

**First responder(s):** The initial responding law enforcement officer(s) and/or other public safety official(s) or service provider(s) arriving at the scene prior to the arrival of the investigator(s) in charge.

**Faraday bag:** Specialty collection bags for electronic parts with lining to protect the contents from electromagnetic forces.

**Fluorescent powders:** Powder intended to reveal latent prints which contain fluorescent chemicals that reveal itself under a forensic light source.

**Forensic light source:** see Alternate light source (ALS).

**Impression evidence:** Objects or materials that have retained the characteristics of other objects that have been physically pressed against them.

**Infrared photography:** A photographic process of recording images by using light from the infrared (IR) spectrum only, generally 700 to 900 nanometers.

**Initial responding officer(s):** The first law enforcement officer(s) to arrive at the scene.

**Investigator(s) in charge:** The official(s) responsible for the crime scene investigation.

**Known:** See comparison samples.

**Latent print:** A print impression not readily visible, made by contact of the hands or feet with a surface resulting in the transfer of materials from the skin to that surface.

**Long-wave ultraviolet (UV) lamp:** An ultraviolet light source that operates between 300-400 nanometers; useful for quickly scanning and documenting crime scenes when used in tandem with a UV-sensitive camera.

**Major case prints:** The recording of all friction ridge detail on the hands. This includes the fingers, fingertips, finger joints and edges of

the fingers as well as the entire palm. Also known as “complete friction ridge exemplars.”

**Matrix:** The substance that is deposited or removed by the friction ridge skin when making an impression.

**Measurement scale:** An object showing standard units of length (e.g., ruler) used in photographic documentation of an item of evidence.

**Multiple scenes:** Two or more physical locations of evidence associated with a crime (e.g., in a crime of personal violence, evidence may be found at the location of the assault and also on the person and clothing of the victim/assailant, the victim’s/assailant’s vehicle, and locations the victim/assailant frequents and resides).

**Nonporous container:** Packaging through which liquids or vapors cannot pass (e.g., glass jars or metal cans).

**Other responders:** Individuals who are involved in an aspect of the crime scene, such as perimeter security, traffic control, media management, scene processing, and technical support, as well as prosecutors, medical personnel, medical examiners, coroners, forensic examiners, evidence technicians, and fire and rescue officers.

**Outsole:** The portion of footwear that is in direct contact with the ground.

**Personal protective equipment (PPE):** Articles such as disposable gloves, masks, and eye protection that are utilized to provide a barrier to keep biological or chemical hazards from contacting the skin, eyes, and mucous membranes and to avoid contamination of the crime scene.

**Porous container:** Packaging through which liquids or vapors may pass (e.g., paper bags, cloth bags).

**Porous surface:** any surface that has tiny openings that absorbs liquids or allows them to pass through (e.g., furniture fabric, canvas, wood, wall board)

**Presumptive test:** A non-confirmatory test used to screen for the presence of a substance.

**Projectile trajectory analysis:** The method for determining the path of a high-speed object through space (e.g., a bullet emanating from a firearm).

**Radiological threat:** The pending exposure to radiation energy. (This energy can be produced by shortwave X-rays or through unstable isotopes.)



**Single-use equipment:** Items that will be used only once to collect evidence, such as biological samples, then discarded to minimize contamination (e.g., tweezers, scalpel blades, droppers).

**Secondary Liner:** Secondary liner is a clear polyester sheet or roll used in industry for stickers, seals, and other adhesive-containing materials to protect the adhesive until ready for use.

**Standard/reference sample:** See comparison samples.

**Substrate:** The surface upon which a friction ridge impression is deposited.

**Team members:** Individuals who are called to the scene to assist in investigation or processing of the scene (e.g., scientific personnel from the crime laboratory or medical examiner's office, other forensic specialists, photographers, mass disaster specialists, experts in the identification of human remains, arson and explosives investigators, clandestine drug laboratory investigators, as well as other experts).

**Trace evidence:** Physical evidence that results from the transfer of small quantities of materials (e.g., hair, textile fibers, paint chips, glass fragments, gunshot residue particles).

**Transient evidence:** Evidence which by its very nature or the conditions at the scene will lose its evidentiary value if not preserved and protected (e.g., blood in the rain).

**Ultraviolet photography:** A photographic process of recording images by using light from the ultraviolet (UV) spectrum only, generally less than 400 nanometers.

**Unknown/questioned:** See comparison samples.

**Walk-through:** An assessment conducted by carefully walking through the scene to evaluate the situation, recognize potential evidence, and determine resources required. Also, a final survey conducted to ensure the scene has been effectively and completely processed.

## Appendix B. Reference List

- Bevel, T. and R. Gardner. *Bloodstain Pattern Analysis*. Boca Raton, Florida: CRC Press, Inc., 1997.
- Bodziak, W.J. *Footwear Impressions Evidence*. New York: Elsevier Science Publishing Co., 1990.
- Crime Scene and Evidence Collection Handbook*. Washington, D.C.: Bureau of Alcohol, Tobacco and Firearms, 1999.
- Colorado Evidence Collection Protocol, Colorado Coalition Against Sexual Assault*, Colorado Bureau of Investigation, 2000.
- Crime Scene Awareness and Investigation*, Vienna, Austria: United Nations Office on Drugs and Crime, 2011.
- Crime Scene Investigation Guidelines*, Mendota Heights, MN: International Association for Identification, 2010.
- Crime Scene Measurement*,  
<https://www.criminology.fsu.edu/faculty/nute/CSmeasurement.html>, (accessed April 13, 2012).
- DeForest, P.R., R.E. Gaensslen, and H.C. Lee. *Forensic Science: An Introduction to Criminalistics*. New York: McGraw-Hill, Inc., 1983.
- FBI Handbook of Forensic Science, Collection, Identification and Shipping Index (with modifications)*. Washington, D.C.: Federal Bureau of Investigation, 1992.
- Fisher, B.A.J. *Techniques of Crime Scene Investigation, 5th Edition*. Boca Raton, Florida: CRC Press Inc., 1993.
- Forensic and Crime Scene Tool Set*, NLECTC – Small, Rural, Tribal and Border Regional Center, National Institute of Justice, Office of Justice Programs, US Department of Justice, 2010.
- Fox, R. H. and C. L. Cunningham. *Crime Scene Search and Physical Evidence Handbook*. Washington, D.C.: U.S. Department of Justice, National Institute of Justice, 1973.
- Geberth, Vernon, J. *Practical Homicide Investigation Checklist and Field Guide*. New York: CRC Press, 1996.
- Guide for the Collection of Footwear and Tire Impressions in the Field. *Journal of Forensic Identification* 770 / 55 (6), 2005.
- Handbook of Physical Evidence*. Miami, Florida: Metro-Dade Police Department, 1996.
- Kirk, P.L. *Crime Investigation, 2nd Edition*. New York: John Wiley & Sons, 1974.

NIST/NIJ Technical Working Group on Biological Evidence  
Preservation: Best Practice Handbook  
[www.cstl.nist.gov/strbase/pub\\_pres/NIJ2012-Kline-TWGBEP.pdf](http://www.cstl.nist.gov/strbase/pub_pres/NIJ2012-Kline-TWGBEP.pdf)

*Physical Evidence Handbook, 8th Edition*. Madison, Wisconsin:  
Wisconsin Department of Justice, 2009.

Physical Evidence Manual, State of Oregon, Forensic Services  
Division, 2008  
<http://egov.oregon.gov/OSP/FORENSICS/LawEnfResources.shtml>,  
(accessed April 14, 2012).

Rini, Gary A. *Crime Scene Search and Physical Evidence Management:  
Student Training Manual*. Elkhorn, Nebraska: The American Institute  
for Police Science, 1998.

Saferstein, R. *Criminalistics: An Introduction to Forensic Science, 6th Edition*.  
Englewood Cliffs, N.J.: Prentice-Hall, 1998.

Saferstein, R. *Forensic Science Handbook*, Volumes I, II, III. Englewood  
Cliffs, N.J.: Prentice-Hall, 1982/1988/1993.

*Suggested Guidelines for Establishing Evidence Response Teams*. Washington,  
D.C.: Federal Bureau of Investigation Laboratory.

## Related References

Dirkmaat, D., E. Chapman, M. Kenyhercz, and L. Cabo. *Enhancing  
Scene Processing Protocols to Improve Victim Identification and Field Detection  
of Human Remains in Mass Fatality Scenes*, Washington, D.C.: U.S.  
Department of Justice, National Institute of Justice, 2012.

Appendix C. Diagrams

C-1 Overview Sketch

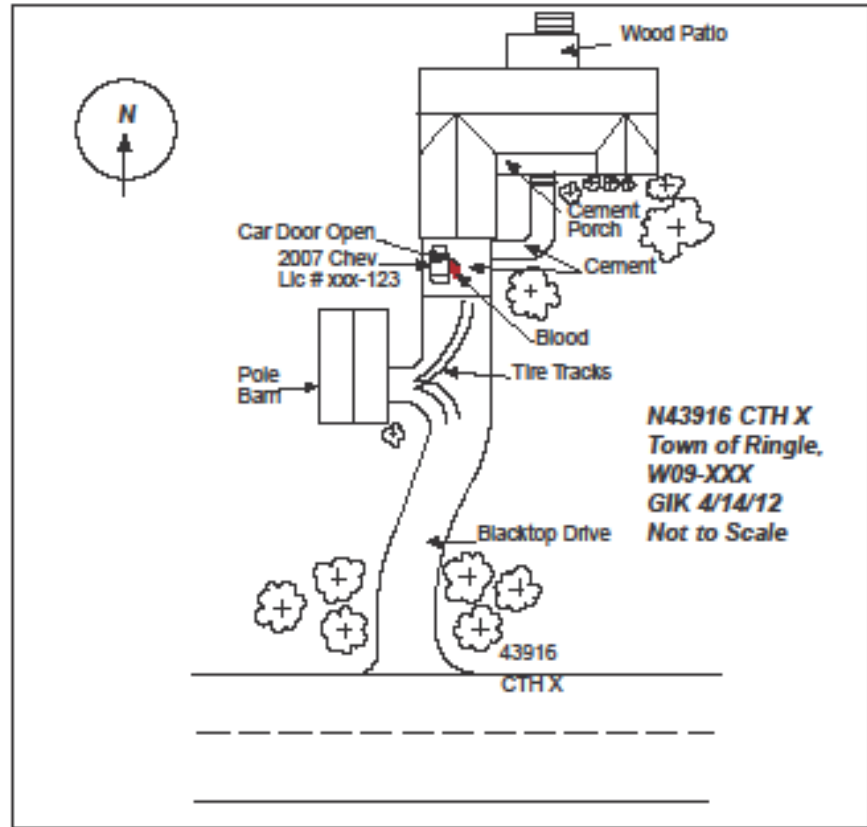

## C-2 Perspective Sketch

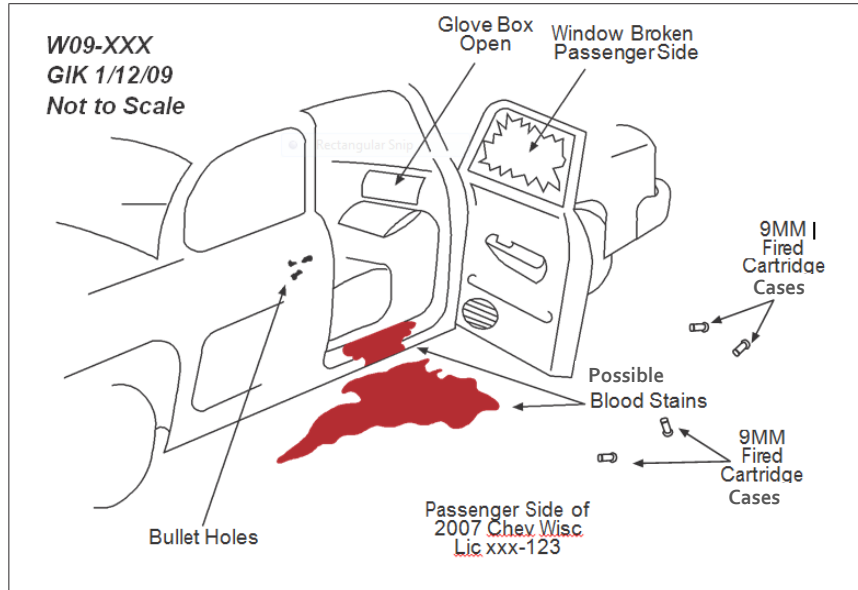

## C-3 Projection Sketch

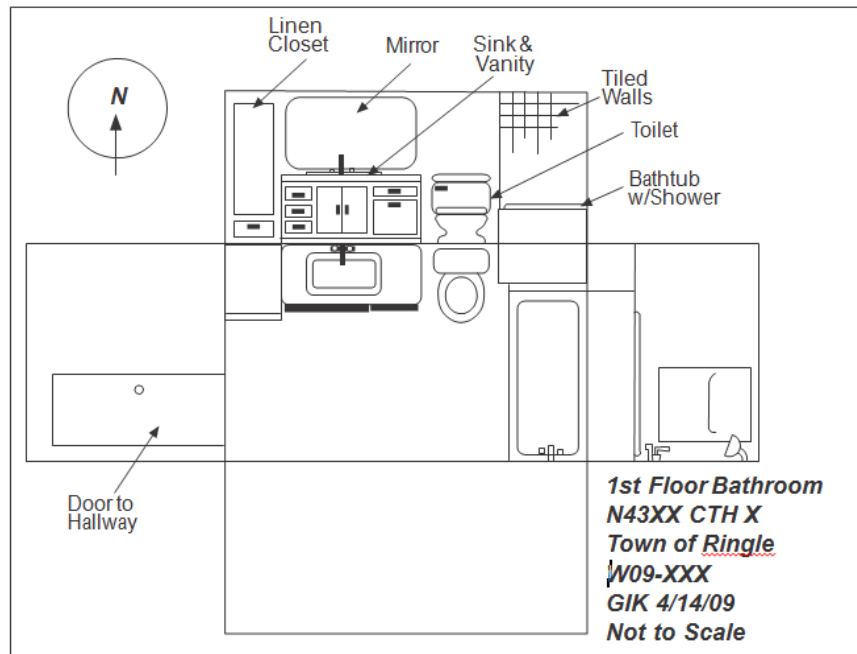

## C-4 Creating a Druggist Bindle

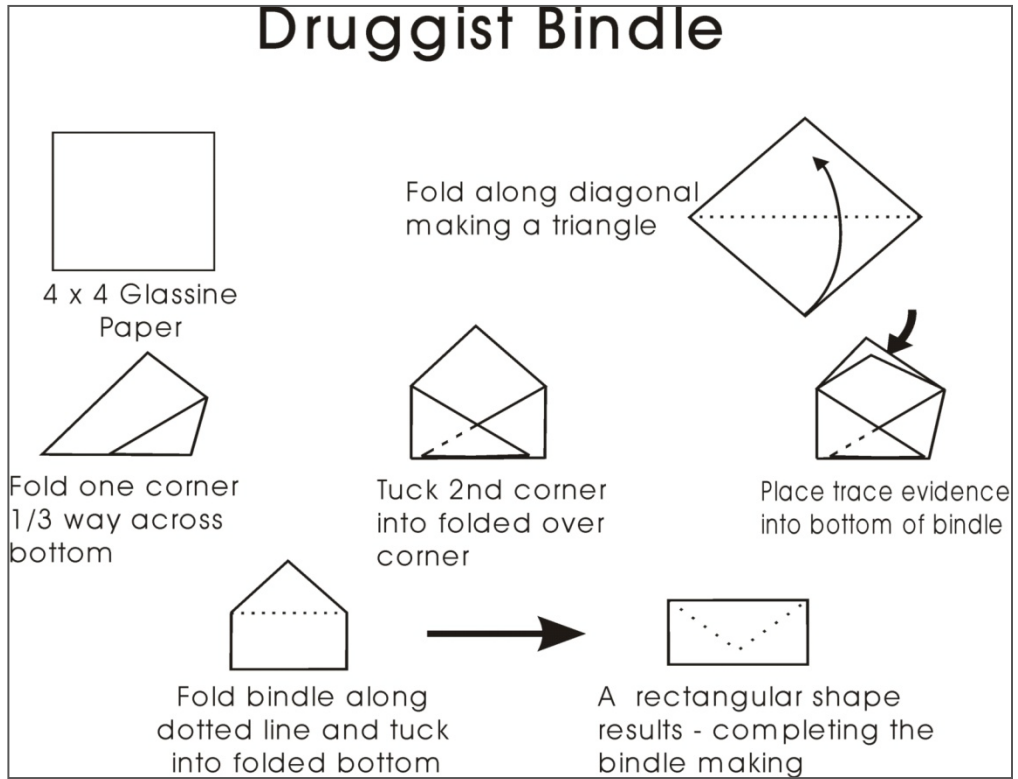

## C-5 Creating an Envelope Bindle

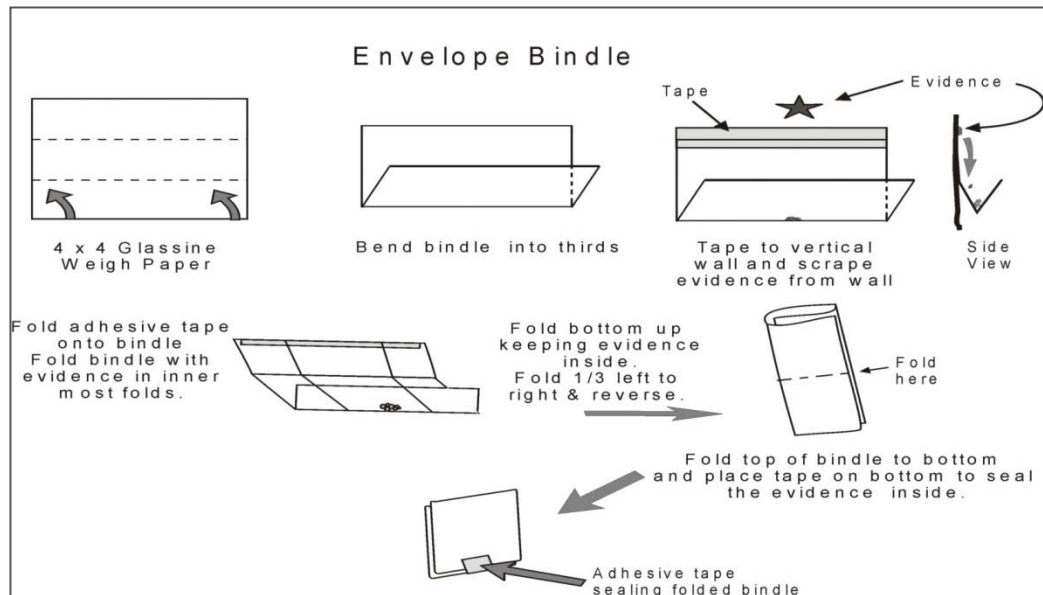

All diagrams courtesy of Wayne Moorehead.

